



Calidad y Servicio desde 1962

Buzones y
productos para
la comunidad
Catálogo 2015





EMPRESA CERTIFICADA
ISO 9001:2008



Oficina y fábrica Zaragoza



EMPRESA CERTIFICADA
ISO 14001:2004



Vista general de la recepción



Exposición producto / Showroom



Miembros Asociación
Empresas de
Seguridad AES



European Security
Systems Association



Punzonadora AMADA



Corte láser TRUMPF



Colabora con
Fundación CEDES



Premio Pilot a
la Excelencia
Logística



European
Recycling
Platform

WEEE
DIRECTIVE
(2003/96/EC)



Robot soldadura REIS



Almacén producto terminado



RoHS
(2002/95/CE)

Restriction of the Use
of Certain Hazardous
Substances in
Electrical and
Electronic Equipment

Catálogo Buzones y Productos para la Comunidad



Calidad y Servicio desde 1962

BTV es una empresa familiar de propiedad 100% aragonesa establecida en 1962, con filiales propias en China (Jiaxing) y Méjico (Cancún), líder en la fabricación de buzones y cajas fuertes para los sectores de ferretería, bricolaje y seguridad.

Nuestros procesos, certificados por las normas ISO 14000 e ISO 9001, van dirigidos a asegurar una entrega inmediata desde nuestro almacén central, con más de 1.500 referencias en sus 5.000m².

BTV pertenece a la Asociación Europea de Sistemas de Seguridad (ESSA) y a la Asociación Española de Empresas de Seguridad (AES), y ensaya periódicamente sus productos en los laboratorios de referencia europeos del sector.



ÍNDICE

Buzones comunidad horizontales - págs. 6 a 23



Avant.....	Pág. 8	Bohemia.....	Pág. 14	Moncayo.....	Pág. 19
Expo.....	Pág. 9	Ordesa.....	Pág. 14	Century.....	Pág. 20
Olympo.....	Pág. 10	Imperio.....	Pág. 15	Century City.....	Pág. 21
Barajas.....	Pág. 11	Silver.....	Pág. 17	Mural Individual.....	Pág. 22
Sevilla.....	Pág. 12	Mercurio.....	Pág. 18	Moncayo Mural.....	Pág. 22
Aneto.....	Pág. 13	Mónaco.....	Pág. 19	Urban.....	Pág. 23

Buzones comunidad verticales - págs. 24 a 35



Ebro.....	Pág. 26	Teide.....	Pág. 29	Horizonte.....	Pág. 33
Paisaje.....	Pág. 26	Londres.....	Pág. 30	Atlantis.....	Pág. 34
Servicios.....	Pág. 27	Alpes.....	Pág. 30	Prisma.....	Pág. 34
Lago.....	Pág. 27	Royal.....	Pág. 31	Prisma frontal.....	Pág. 35
Venus.....	Pág. 28	Génova.....	Pág. 33		

Buzones comunidad madera - págs. 36 a 43



Niza.....	Pág. 38	Dinamarca.....	Pág. 40	Soportes grupos.....	Pág. 42
Toledo.....	Pág. 38	Bruselas.....	Pág. 41	Otros modelos.....	Pág. 43
Astún.....	Pág. 39	Támesis.....	Pág. 41		
Ronda.....	Pág. 39	Acabados.....	Pág. 42		

Buzones individuales exterior - págs. 44 a 63



Plástico		Riviera.....	Pág. 51	Tokio.....	Pág. 57
Galaxy.....	Pág. 46	Logo.....	Pág. 51	Lisboa inox.....	Pág. 58
Mallorca.....	Pág. 46	Dakota acero.....	Pág. 52	Nano inox.....	Pág. 58
Ibiza.....	Pág. 47	Lisboa acero.....	Pág. 53	Berlín inox.....	Pág. 59
Garden.....	Pág. 47	Nano acero.....	Pág. 54	Forja.....	Pág. 59
Acero		Berlín acero.....	Pág. 54	Aluminio	
Chalet.....	Pág. 49	Góndola acero.....	Pág. 55	Alhambra.....	Pág. 61
Colonia.....	Pág. 49	Posta.....	Pág. 55	Imperial.....	Pág. 61
Castillo.....	Pág. 50	Acero Inoxidable		Ibiza aluminio.....	Pág. 62
Cortijo.....	Pág. 50	Góndola inox.....	Pág. 57	Dakota aluminio.....	Pág. 63

Buzones individuales paquetería, doble boca y usos especiales - págs. 64 a 71



Panera.....	Pág. 66	Oslo	Pág. 68	Recoge cartas	Pág. 70
Pack- Box	Pág. 67	Casilleros.....	Pág. 69	Bocacartas	Pág. 71

Equipamiento y accesorios - págs. 72 a 85



Agrupaciones y rotulación	Pág. 74	Marquesinas	Pág. 80	exterior	Pág. 83
Envoltentes	Pág. 76	Tejados / Iluminación LED.....	Pág. 81	Tarjeteros.....	Pág. 84
Tapajuntas	Pág. 77	Colores y acabados.....	Pág. 82	Cerraduras	Pág. 85-87
Soportes y brazos	Pág. 78	Soporte Anticaída.....	Pág. 83		
Soportes	Pág. 79	Sujeta buzones			

Rotulación - págs. 88 a 95



Placas Fun	Pág. 90	Expositor Rotulación	Pág. 90	Señalización Homologada.....	Pág. 95
Rótulos zonas comunes	Pág. 90	Placas Classic	Pág. 91		
Embellecedor / Separador	Pág. 90	Señalización	Pág. 92-93		
		Colgadores Easy	Pág. 94		

Seguridad y videovigilancia - págs. 96 a 102



Videovigilancia.....	Pág. 98-99	Domótica.....	Pág. 102
Cerraduras electrónicas	Pág. 100-101	Llaveros de seguridad	Pág. 102

Complementos - págs. 103 a 120



Anuncios	Pág. 104	Papeleras	Pág. 110-111	Botiquines	Pág. 116-117
Imanes	Pág. 105	Cajas de caudales ...	Pág. 112	Linternas y pilas.....	Pág. 118
Clasificadores llaves	Pág. 106-107	Huchas	Pág. 113		
Cestas publicidad	Pág. 108-109	Guardallaves	Pág. 114		
		Caja de ocultación ...	Pág. 114		
		Ceniceros	Pág. 115		

GUIA PARA ELEGIR SU BUZÓN EN 5 PASOS

1 TIPO DE BUZÓN

COMUNIDADES

Agrupaciones de buzones para comunidades con múltiples propietarios (Págs. 7 a 43)



INDIVIDUAL

Buzón exterior para chalets o casas individuales (Págs. 44 a 71)



2 FORMA DE INSTALACIÓN

EMPOTRADOS

De Stock (Págs. 7 a 19 / 22 a 35)
Especial Madera (Págs. 37 a 43)



COLGADOS

De Stock (Págs. 7 a 19 / 22 a 35)
Especial Madera (Págs. 37 a 43)
Individual (Págs. 45 a 70)



SOBRE SOPORTES

De Stock (Págs. 7 a 35)
Especial Madera (Págs. 37 a 43)

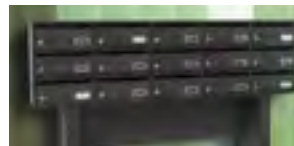

MURAL

Stock (Pág. 22)
Bajo Pedido (Págs. 23)



3 FORMATO

HORIZONTAL



VERTICAL



VERTICAL LIBRO



4 MATERIAL

ACERO PINTADO

Buzones robustos de acero pintados en pintura poliéster blanco, negro, plata, titanio, etc.

ACERO INOXIDABLE

Los buzones en acero inoxidable se aprecian por su modernidad y brillo. Son duraderos y sólidos. Inoxidables de calidad AISI 304 (en mods. señalados).

ALUMINIO

Limpio, ligero, resistente y no oxidable.

MADERA Y MELAMINA

Un material elegante y cálido, con multitud de acabados.

PLÁSTICO

Ligero, resistente, no oxidable y duradero. En ABS o resina epoxi.

5 COMPLEMENTOS

ROTULACIÓN

(Págs. 74,75 y 89 a 95)



TAPAJUNTAS Y ENVOLVENTES

(Págs. 76 a 77)



SOPORTES Y BRAZOS

(Págs. 78 a 79)



MARQUESINAS Y TEJADOS

(Págs. 80 a 81)



BTV tiene especial interés en facilitar el trabajo de sus clientes; para ello ofrecemos una serie de **herramientas de gran utilidad**:

PORTAL BTV

Para hacer pedidos y consultas sobre nuestros productos en cualquier momento del día. Si eres cliente de BTV, contacta con nosotros para obtener una clave de acceso con la que poder acceder al portal de pedidos.



DBOX

Nunca hacer un presupuesto de BTV fue tan fácil. Entra en el apartado DBOX de nuestra web para comprobarlo. La plataforma indica uno a uno los pasos a seguir para obtener el presupuesto de un grupo de buzones con su equipamiento, como soportes, envolveres, tejados... a gusto del consumidor.



PICTOGRAMAS



buzón apto uso exterior



buzón apto uso interior



Antivandálico



Anticorrosión

APERTURA



lateral



hacia arriba



hacia abajo



Medidas bocacartas

CERRADURA



rombo



cuadrada



redonda



pomo

MATERIAL CONSTRUCCIÓN CUERPO



acero



inox
inoxidable



aluminio



madera



>ABS<
ABS



plástico

MATERIAL CONSTRUCCIÓN PUERTA



inox
inoxidable



aluminio



madera



metacrilato



BUZONES COMUNIDADES HORIZONTAL

Indice alfabético

Aneto		Pág. 13	Mónaco		Pág. 19
Avant		Pág. 8	Moncayo		Pág. 19
Barajas		Pág. 11	Moncayo Mural		Pág. 22
Bohemia		Pág. 14	Mural Aluminio		Pág. 22
Century		Pág. 20	Mural Urban		Pág. 23
Century City		Pág. 21	Olympo		Pág. 10
<i>Novedad</i> Expo		Pág. 9	Ordesa		Pág. 14
Imperio		Pág. 15	Sevilla		Pág. 12
Mercurio		Pág. 18	Silver		Pág. 17

Indice por páginas

Avant.....	Pág. 8	Silver	Pág. 17
Expo.....	Pag. 9	Mercurio	Pág. 18
Olympo	Pág. 10	Mónaco.....	Pág. 19
Barajas.....	Pág. 11	Moncayo	Pág. 19
Sevilla.....	Pág. 12	Century	Pág. 20
Aneto	Pág. 13	Century City	Pág. 21
Bohemia.....	Pág. 14	Mural Aluminio.....	Pág. 22
Ordesa	Pág. 14	Moncayo Mural.....	Pág. 22
Imperio.....	Pág. 15	Mural Urban	Pág. 23

AVANT



60463

Puertas de metacrilato de 4 mm. varios colores. Cuerpo construido en acero pintado en negro con junquillo de aluminio anodizado natural. Una nota de color en la decoración contemporánea. **Cerradura Grado 1 según normativa EN-13724.**

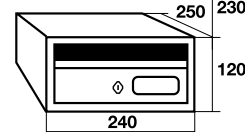
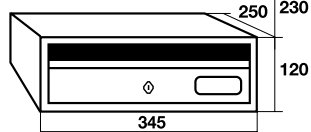
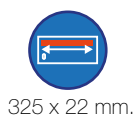

2B

Ejemplo troquelado

OPCIÓN TROQUELADO SOBRE METACRILATO*

Cod.	Uds.	€
10435	de 1 a 3 caracteres	6,50
10436	de 4 a 10 caracteres	7,90

* Mínimo 20 buzones

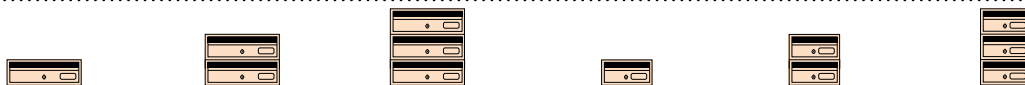

medidas	120 x 345 x 250						120 x 240 x 250					
	Colores		Cód.	€	Cód.	€	Cód.	€	Cód.	€	Cód.	€
Cuerpo / Puerta												
Negro / Blanco	15106	33,30	25106	66,60	35106	99,90	15216	28,65	25216	57,30	35216	85,95
Negro / Amarillo girasol	15104	33,30	25104	66,60	35104	99,90	15214	28,65	25214	57,30	35214	85,95
Negro / Azul	15101	33,30	25101	66,60	35101	99,90	15211	28,65	25211	57,30	35211	85,95
Negro / Gris oscuro	15107	33,30	25107	66,60	35107	99,90	15217	28,65	25217	57,30	35217	85,95
Negro / Naranja	15103	33,30	25103	66,60	35103	99,90	15213	28,65	25213	57,30	35213	85,95
Negro / Rojo cereza	15102	33,30	25102	66,60	35102	99,90	15212	28,65	25212	57,30	35212	85,95
Negro / Verde menta	15105	33,30	25105	66,60	35105	99,90	15215	28,65	25215	57,30	35215	85,95
Uds./caja			5	3	2		5	3	2			



EXPO



60464

Cuerpos de acero pintado negro. Puertas de aluminio anodizado o pintado de 1,5 mm. de espesor. Viseras de aluminio anodizado o pintado. **Cerradura Grado 1 según normativa EN-13724.**
Apto para uso en exterior.

Novedad

Colores personalizados
Ver pág. 82



325 x 30 mm.

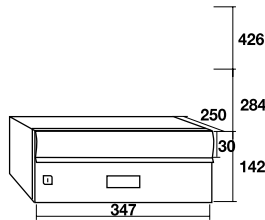

225 x 30 mm.

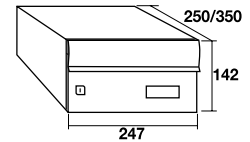

A
OPCIÓN
GRABADO

A
OPCIÓN
GRABADO
HUECO



Uds.	Cod.	Cod.	€
de 1 a 3 caracteres	10431	10433	5,90
de 4 a 10 caracteres	10432	10434	7,40

* Mínimo 20 buzones



medidas	142 x 347 x 250				142 x 247 x 350		142 x 247 x 250			
	Cód.	€	Cód.	€	Cód.	€	Cód.	€		
Negro / Blanco	12201	45,00	22201	90,00	32201	135,00	12204	42,00	18214	39,00
Negro / Negro	12202	45,00	22202	90,00	32202	135,00	12205	42,00	18215	39,00
Negro / Alum. anodizado	11203	47,00	21203	94,00	31203	141,00	11206	44,00	14216	41,00
Uds./caja	5		3		2		5		5	

✓ Stock permanente: envío garantizado en 24 horas



OLYMPO

Construidos totalmente en aluminio. Cuerpo negro y puerta en negro o aluminio natural anodizado. Cerradura Grado 1 según normativa EN-13724.



60465



325 x 30 mm.

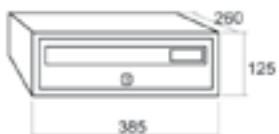

227 x 30 mm.

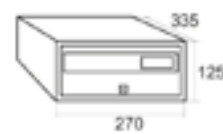

medidas	125 x 385 x 260		125 x 270 x 335	
	Cód.	€	Cód.	€
✓ Negro / Natural	11401	42,50	11403	37,50
✓ Negro / Negro	11402	42,50	11404	37,50

✓ Stock permanente: envío garantizado en 24 horas

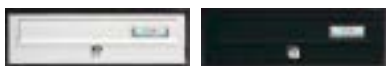

BARAJAS

Cuerpos de acero pintado negro. Puertas de acero pintado o acero inoxidable (calidad AISI 304).
Cerradura Grado 1 según normativa EN-13724.



Colores personalizados
Ver pág. 82

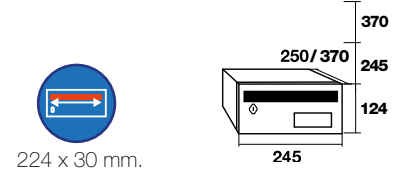
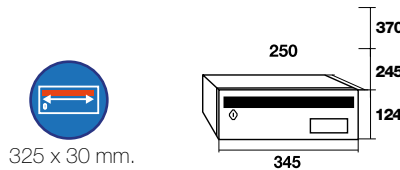

A
OPCIÓN
GRABADO

A
OPCIÓN
GRABADO
HUECO

Uds.	Cod.	Cod.	€
de 1 a 3 caracteres	10431	10433	5,90
de 4 a 10 caracteres	10432	10434	7,40

* Mínimo 20 buzones



medidas	124 x 345 x 250			124 x 245 x 250			124 x 245 x 370											
	Cód.	€	Cód.	€	Cód.	€	Cód.	€	Cód.	€								
✓ Negro/Inox. brillo	16346	29,60	26346	59,20	36346	88,80	16726	24,90	26726	49,80	36726	74,70	10336	26,50	20336	53,00	30336	79,50
✓ Negro / Negro	16524	23,25	26524	46,50	36524	69,75	16720	20,10	26720	40,20	36720	60,30	10320	23,25	20320	46,50	30320	69,75
Negro/Arena perla	16349	26,25	26349	52,50	36349	78,75	16924	22,60	26924	45,20	36924	67,80	10379	26,25	20379	52,50	30379	78,75
Negro / Magma	16624	26,25	26624	52,50	36624	78,75	16724	22,60	26724	45,20	36724	67,80	10324	26,25	20324	52,50	30324	78,75
Negro / Plata	16329	26,25	26329	52,50	36329	78,75	16829	22,60	26829	45,20	36829	67,80	10329	26,25	20329	52,50	30329	78,75
✓ Negro / Titanio	16326	25,75	26326	51,50	36326	77,25	16824	22,10	26824	44,20	36824	66,30	10346	25,75	20346	51,50	30346	77,25
Uds./caja	5		3		2		5		3		2		5		3		2	

✓ Stock permanente: envío garantizado en 24 horas

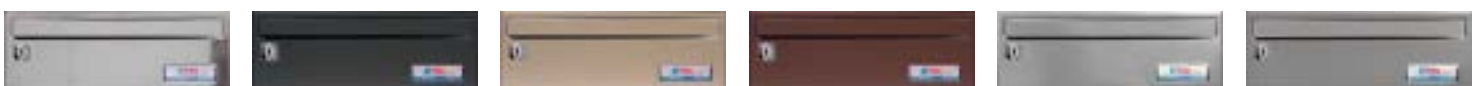

SEVILLA

Cuerpos de acero pintado en negro excepto modelos en inoxidable, titanio y blanco. Puertas en acero pintado y acero inoxidable (Calidad AISI 304).



60425



Colores personalizados
Ver pág. 82



325 x 20 mm.

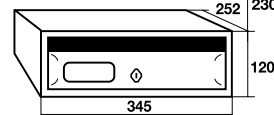

medidas		120 x 345 x 252					
Colores Cuerpo / Puerta	Cód.	€	Cód.	€	Cód.	€	
Inox. brillo /Inox. brillo	16030	49,00	26030	98,00	36030	147,00	
✓ Negro /Inox. brillo	16006	28,60	26006	57,20	36006	85,80	
Blanco / Blanco	16001	22,90	26001	45,80	36001	68,70	
✓ Negro / Arena perla	16009	25,40	26009	50,80	36009	76,20	
Negro / Magma	16024	25,90	26024	51,80	36024	77,70	
✓ Titanio / Titanio	16025	25,40	26025	50,80	36025	76,20	
Uds./caja	5		3		2		

✓ Stock permanente: envío garantizado en 24 horas

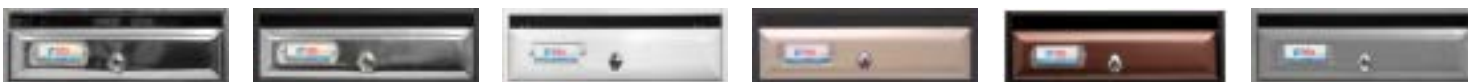

ANETO

Cuerpo de acero pintado negro. Puertas en acero pintado, acero inoxidable o madera barnizada.
Cerradura Grado 1 según normativa EN-13724.



Colores personalizados
Ver pág. 82

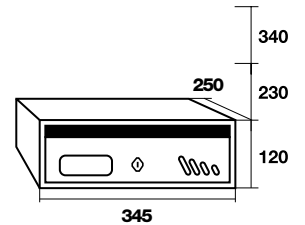

medidas		120 x 345 x 250					
Colores Cuerpo / Puerta	Cód.	€	Cód.	€	Cód.	€	
Negro / Inox. brillo	15006	28,15	25006	56,30	35006	84,45	
Negro / Plata	15029	23,00	25029	46,00	35029	69,00	
Negro / Ebano	15111	36,50	25111	73,00	35111	109,50	
Negro/Sapelli barnizado	15008	33,70	25008	67,40	35008	101,10	
Negro / Zebrano	15110	36,50	25110	73,00	35110	109,50	
Uds./caja	5		3		2		

✓ Stock permanente: envío garantizado en 24 horas



BOHEMIA



madera 60448
inox 60449



325 x 20 mm.

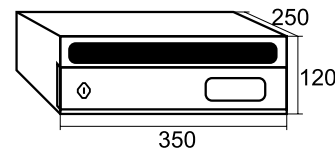

medidas		120 x 345 x 252	
Colores Cuerpo / Puerta		Cód.	€
✓	Inox. brillo	16856	27,90
✓	Cerezo	06852	24,20
✓	Haya	06851	24,20
✓	Nogal oscuro	06853	24,20
Uds./caja		6	

✓ Stock permanente: envío garantizado en 24 horas



ORDESA



60442



325 x 20 mm.

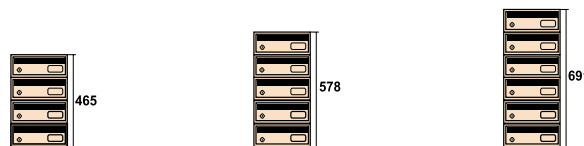
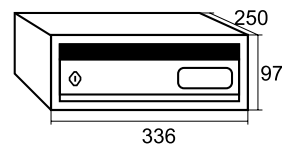

medidas		126 x 336 x 250					
Colores		Cód.	€	Cód.	€	Cód.	€
✓	Haya	46601	140,00	56601	175,00	66601	210,00
✓	Nogal oscuro	46602	140,00	56602	175,00	66602	210,00

✓ Stock permanente: envío garantizado en 24 horas



Buzón de melamina en stock con entrega inmediata para formar composiciones. Con visor inferior de metacrilato. Cuerpo en haya y nogal oscuro. Disponibles en grupo de 4, 5 y 6 unidades

IMPERIO



60442



Envolvente en acero pintado negro, con puerta y marco en aluminio anodizado o acero inoxidable (calidad AISI 304).
 Construcción sólo en agrupaciones bajo pedido, mínimo grupo de 4 unidades. Plazo de entrega: 4 semanas.
 Peso 1,3 Kg.

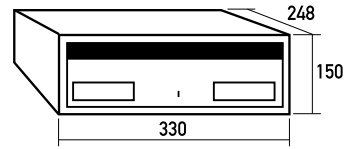

		NUMERO DE UNIDADES POR CONJUNTO							
		10	20	30	40	50	60	70	80
ALTURA DEL CONJUNTO	-	10	20	30	40	50	60	70	80
	1240	9	18	27	36	45	54	63	72
	1104	8	16	24	32	40	48	56	64
	968	7	14	21	28	35	42	49	56
	832	6	12	18	24	30	36	42	48
	696	5	10	15	20	25	30	35	40
	560	4	8	12	16	20	24	28	32
	424	3	6	9	12	15	18	21	24
	288	2	4	6	8	10	12	14	16
152	1	2	3	4	5	6	7	8	
		342	668	994	1320	1646	1972	2298	-
		ANCHO DEL CONJUNTO							

Colores Envolvente / Puerta	Cód.	€
Negro / Acero Inox Brillo	02808	71,60
Negro / Negro	02834	52,50
Negro / Alum. Anodizado	02801	52,50



* Para muebles inferiores a 4 unidades tienen un suplemento del 50% sobre precio de venta en agrupaciones mínimas de 4

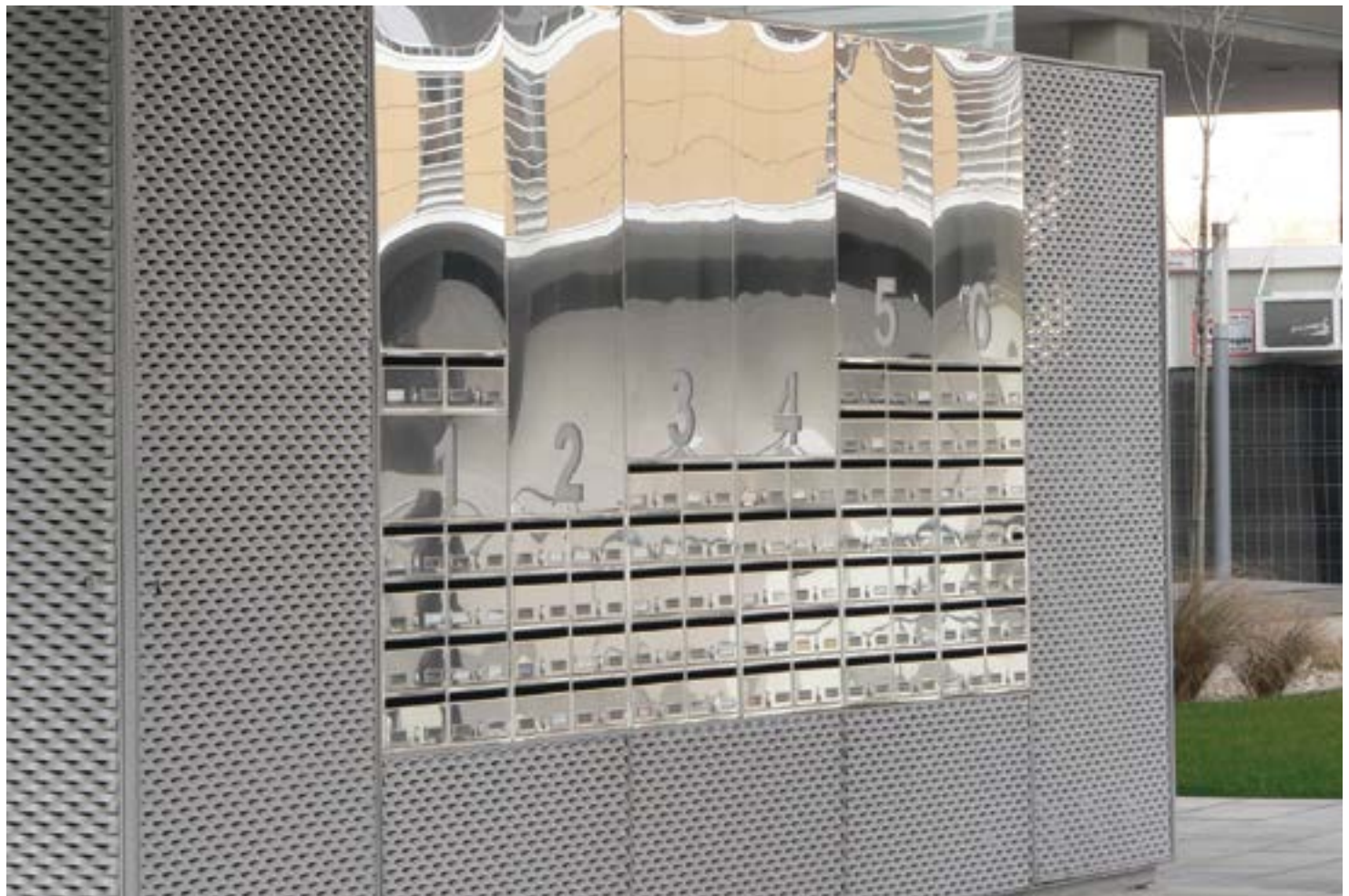



SILVER



Cuerpos de acero pintado y puertas de acero inoxidable (calidad AISI 304) o acero pintado. Ahora disponibles en stock en fondo 370 mm. **Cerradura Grado 1 según normativa EN-13724.**



Colores personalizados
Ver pág. 82



230 x 30 mm.

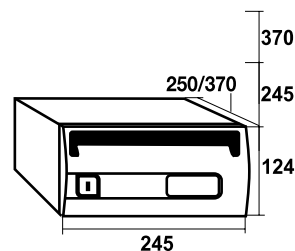

medidas	124 x 245 x 250						124 x 245 x 370					
	Colores Cuerpo / Puerta	Cód.	€	Cód.	€	Cód.	€	Cód.	€	Cód.	€	
✓ Negro/Inox. mate	13716	21,30	23716	42,60	33716	63,90	13727	24,30	23727	48,60	33727	72,90
✓ Negro/Negro	13720	16,00	23720	32,00	33720	48,00	13729	19,00	23729	38,00	33729	57,00
Negro/Arena perla	13709	18,50	23709	37,00	33709	55,50	13728	21,50	23728	43,00	33728	64,50
Negro/Magma	13717	18,50	23717	37,00	33717	55,50	13731	21,50	23731	43,00	33731	64,50
Negro/Titanio	13726	18,50	23726	37,00	33726	55,50	13730	21,50	23730	43,00	33730	64,50
Uds./caja		10		6		4		5		3		2

✓ Stock permanente: envío garantizado en 24 horas



MERCURIO



60401

Cuerpos de acero pintado en negro excepto en modelos color blanco y puertas de acero inoxidable (calidad AISI 304) o acero pintado.



Colores personalizados
Ver pág. 82



230 x 30 mm.

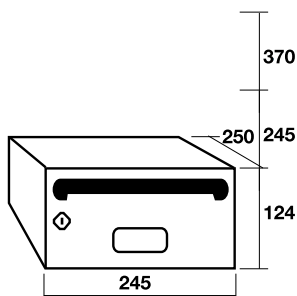

medidas		124 x 245 x 250					
Colores Cuerpo / Puerta	Cód.	€	Cód.	€	Cód.	€	
✓ Negro/Inox. brillo	13506	21,30	23506	42,60	33506	63,90	
✓ Blanco/Blanco	13514	16,00	23514	32,00	33514	48,00	
Negro/Negro	13520	16,00	23520	32,00	33520	48,00	
Negro/Arena perla	13509	18,50	23509	37,00	33509	55,50	
✓ Negro/Plata	13529	18,00	23529	36,00	33529	54,00	
Uds./caja	10		6		4		

✓ Stock permanente: envío garantizado en 24 horas



MONCAYO



60466



Colores personalizados
Ver pág. 82

197 x 24 mm.

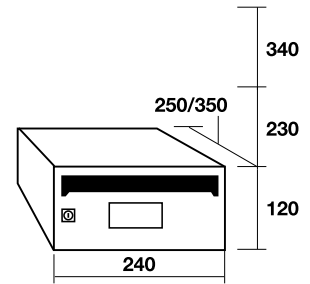

Cuerpos de acero pintado en negro, excepto en modelos color blanco y titanio. Puertas en acero pintado, skimplate y acero inoxidable (calidad AISI 304).
Cerradura Grado 1 según normativa EN-13724.
También disponible en versión mural (pág. 22).

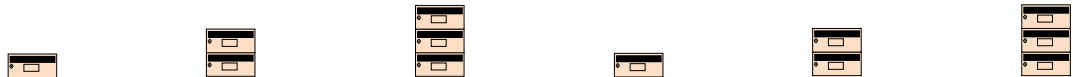

medidas	120 x 240 x 250						120 x 240 x 350						
	Colores Cuerpo / Puerta	Cód.	€	Cód.	€	Cód.	€	Cód.	€	Cód.	€		
✓	Negro/Inox. brillo	13906	23,00	23906	46,00	33906	69,00	16206	25,75	26206	51,50	36206	77,25
	Blanco/Blanco	13909	17,50	23909	35,00	33909	52,50	16214	20,00	26214	40,00	36214	60,00
✓	Negro/Negro	13920	17,50	23920	35,00	33920	52,50	16220	20,00	26220	40,00	36220	60,00
	Negro/Oro	13905	20,00	23905	40,00	33905	60,00	16205	22,50	26205	45,00	36205	67,50
✓	Negro/Plata	13929	19,50	23929	39,00	33929	58,50	16219	21,50	26219	43,00	36219	64,50
	Negro/Skimplate	13903	21,00	23903	42,00	33903	63,00	16203	23,50	26203	47,00	36203	70,50
	Titanio/Titanio	13925	20,00	23925	40,00	33925	60,00	16225	22,50	26225	45,00	36225	67,50
	Uds./caja	10		6		4		5		3		2	

✓ Stock permanente: envío garantizado en 24 horas



MÓNACO



60467



Acero pintado y puertas en chapeado de madera barnizada. **Cerradura Grado 1 según normativa EN-13724.**

190 x 22 mm.

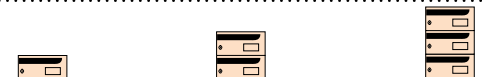
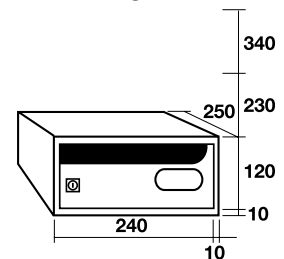

medidas	120 x 240 x 250					
Colores Cuerpo / Puerta	Cód.	€	Cód.	€	Cód.	€
Negro / Pino Oregón	13604	30,45	23604	60,90	33604	91,35
Negro / Roble	13611	30,45	23611	60,90	33611	91,35
Negro / Sapelli	13606	30,45	23606	60,90	33606	91,35

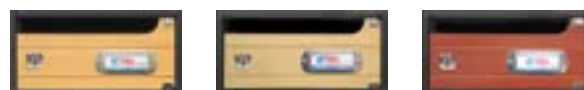

CENTURY



60466

Buzones concentrados pluridomiciliarios ideales para la recepción de correspondencia en zonas dispersas: urbanizaciones, polígonos industriales y diseminados.

Cerradura Grado 1 según normativa EN-13724. Fabricado en acero inoxidable (calidad AISI 304).

Plazo de entrega: 4 semanas.

HORIZONTAL

MADERA VERTICAL

BUZONES COMUNIDAD

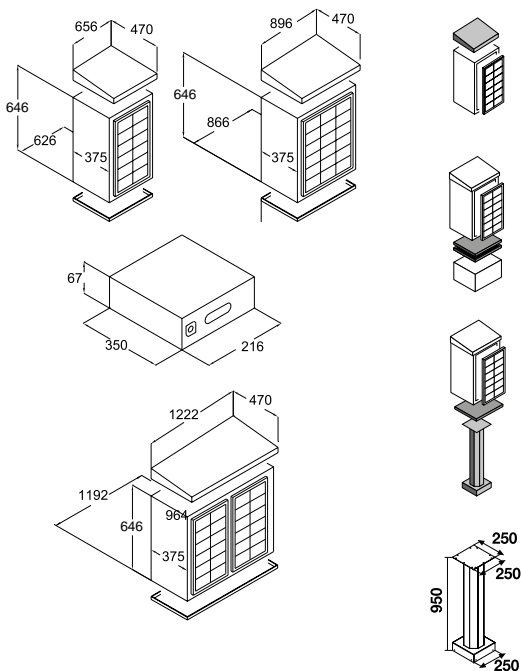

	12 unid.		18 unid		24 unid.	
	Cód.	€	Cód.	€	Cód.	€
Buzones (Sin tejado)	02857	1060,00	02858	1530,00	02859	1990,00
Complementos						
Tejado	10596	77,50	10597	120,00	10598	147,00
Bases + Contrabases (instalación sobre muro)	10570	84,00	10571	125,00	10572	166,50
Bases Acero (instalación sobre pie)	10176	42,00	10177	63,50	10178	82,90
Soporte (precio/ud.)	04213				169,20	
Peso	39 Kg.		51,5 Kg.		69 Kg.	

Los modelos de 24 unidades necesitan dos soportes.

CENTURY CITY



60502

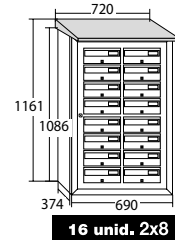
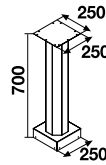
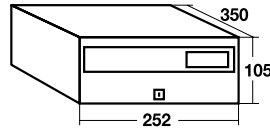

16 unid. 2x8

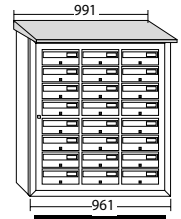

24 unid. 3x8

Buzones pluridomiciliarios con bocacartas y puerta general de entrega de correo. Cuerpo en acero inoxidable (calidad AISI 304) o acero galvanizado pintado. Puertas en aluminio anodizado o pintado. Plazo de entrega 4 semanas.

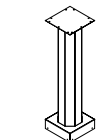
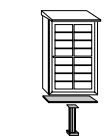
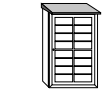
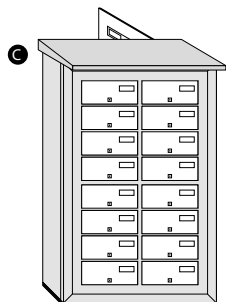
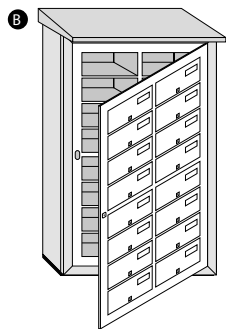
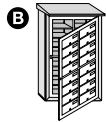
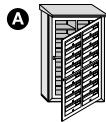
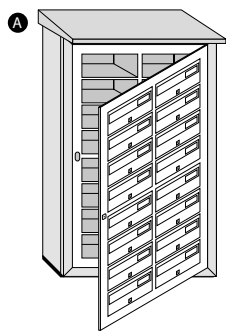

	Colores	16 unid. - 2x8		24 unid. - 3x8	
		Cód.	€	Cód.	€
Puertas con solapa (Sin tejado)	Cuerpo Inox. Pta. Anodizado natural	10580	1490,00	10581	2115,00
	Cuerpo/puerta Negro	10584	1120,00	10585	1595,00
Puertas ciegas (Sin tejado)	Cuerpo Inox. Pta. Anodizado natural	10630	1410,00	10631	1995,00
	Cuerpo/puerta Negro	10636	1040,00	10637	1475,00
Doble cara con solapas en parte frontal (Sin tejado)	Cuerpo Inox. Pta. Anodizado natural	10646	1490,00	10647	2115,00
	Cuerpo/puerta Negro	10650	1120,00	10651	1595,00

Complementos

Tejado	Acero Inoxidable	10590	68,50	10591	92,50
	Negro	10594	43,00	10595	59,00
Bases + Contrabases (instalación sobre muro)	Acero Inoxidable	10600	102,00	10601	134,00
	Negro	10604	49,00	10605	62,50
Bases Acero (instalación sobre pie)	Acero Inoxidable	10610	51,00	10611	67,00
	Negro	10614	54,50	10615	72,00
Soporte (precio/ud.)	Acero Inoxidable	10217	149,50		
	Negro	10219	78,00		

MURAL INDIVIDUAL



Doble puerta para evitar el acceso de intrusos. Entrega de correo desde la calle. Recogida desde el interior. Consultar equipamiento de comunidades para envolventes de grupos y placas de portero.

Puertas interior y exterior en aluminio natural. Cuerpo de acero pintado negro. Modelo horizontal con fondo regulable de 270 a 430 mm.



Modelo Vertical

Vista lado interior

Vista lado exterior

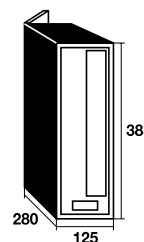
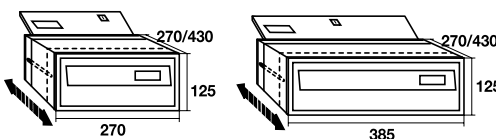

medidas	HORIZONTAL TELESCÓPICO				VERTICAL	
Colores	Cód.	€	Cód.	€	Cód.	€
Aluminio anodizado natural	66310	69,00	66311	79,50	03560	82,00
Uds./caja	4				4	

MONCAYO MURAL



60466

Construidos en acero galvanizado pintado. Doble cara. Puertas de recepción en acero pintado y acero inoxidable brillo (calidad AISI 304). Fabricación individual, opción de crear grupos.

Cerradura Grado 1 según normativa EN-13724.



217 x 25 mm.

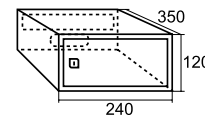
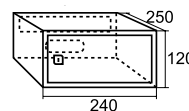

Colores	Fondo 250		Fondo 350	
Lado exterior / Puerta interior	Cód.	€	Cód.	€
✓ Negro / Inox. Brillo	03532	31,30	03521	36,80
✓ Blanco / Blanco	03531	27,20	03522	32,85
✓ Negro / Negro	03520	27,20	03523	32,85
Uds./caja	10			

✓ Stock permanente: envío garantizado en 24 horas



URBAN



60455

Buzón de fabricación especial con frontal exterior construido en una sola pieza y fondo según la necesidad del cliente. Fabricado en acero galvanizado y acero inoxidable (calidad AISI 304).

Cerradura Grado 1 según normativa EN-13724.

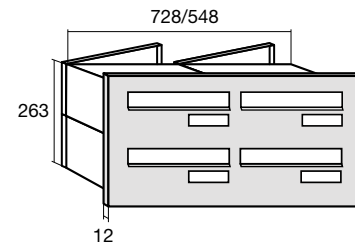

Frontal exterior con perfil doblado de 12 mm



350 x 30 mm.

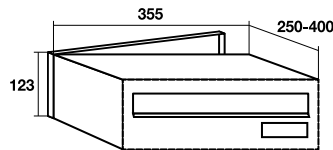

230 x 30 mm.

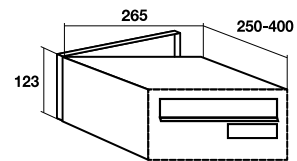

Medidas frontal exterior buzón Urban

ALTO		ANCHO - Mod. 355 mm.			ANCHO - Mod. 265 mm.			
		1 buzón	2 buzones	3 buzones	1 buzón	2 buzones	3 buzones	4 buzones
		373 mm.	728 mm.	1083 mm.	283 mm.	548 mm.	813 mm.	1078 mm.
1 buzón	140 mm.	373 x 140	728 x 140	1083 x 140	283 x 140	548 x 140	813 x 140	1078 x 140
2 buzones	263 mm.	373 x 263	728 x 263	1083 x 263	283 x 263	548 x 263	813 x 263	1078 x 263
3 buzones	386 mm.	373 x 386	728 x 386	1083 x 386	283 x 386	548 x 386	813 x 386	1078 x 386
4 buzones	509 mm.	373 x 509	728 x 509	1083 x 509	283 x 509	548 x 509	813 x 509	1078 x 509
5 buzones	632 mm.	373 x 632	728 x 632	1083 x 632	283 x 632	548 x 632	813 x 632	1078 x 632
6 buzones	755 mm.	373 x 755	728 x 755	1083 x 755	283 x 755	548 x 755	813 x 755	1078 x 755
7 buzones	878 mm.	373 x 878	728 x 878	1083 x 878	283 x 878	548 x 878	813 x 878	1078 x 878
8 buzones	1001 mm.	373 x 1001	728 x 1001	1083 x 1001	283 x 1001	548 x 1001	813 x 878	1078 x 878
9 buzones	1124 mm.	373 x 1124	728 x 1124	1083 x 1124	283 x 1124	548 x 1124	813 x 1124	1078 x 1124
10 buzones	1247 mm.	373 x 1247	728 x 1247	1083 x 1247	283 x 1247	548 x 1247	813 x 1124	1078 x 1247

Nota: Para hallar la medida de la trasera del conjunto, restar 16 mm tanto en alto como en ancho a la medida resultante de la tabla.

Colores	Ancho 265 mm.		Ancho 355 mm.	
	Cód.	€*	Cód.	€*
Acero Inox Brillo	10665	57,20	10661	63,40
Acero Inox Mate **	10666	57,20	10662	63,40
Acero blanco	10667	51,40	10663	56,25
Acero Negro	10668	51,40	10664	56,25

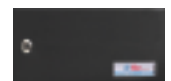
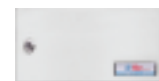





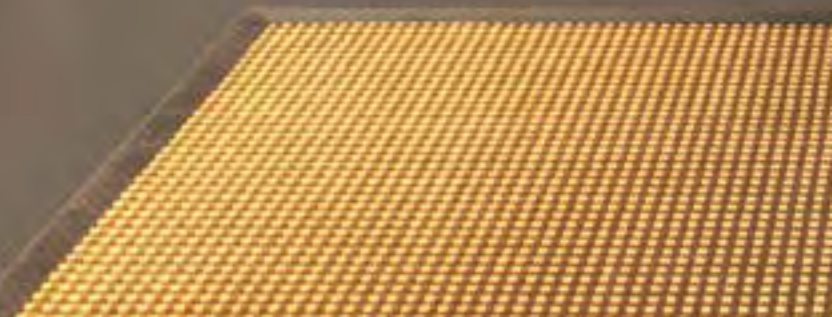
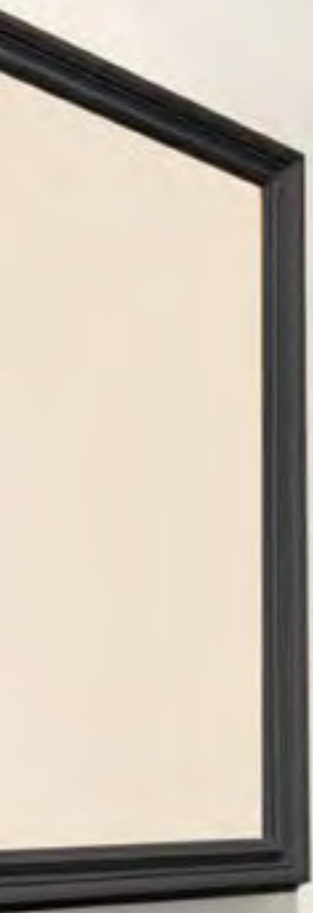







* Los precios indicados corresponden a 1 buzón. Para muebles inferiores a 4 unidades existe un suplemento del 50% sobre precio de venta.

** Inox. mate: Plazo de entrega 6 semanas



BUZONES COMUNIDADES VERTICAL

Indice alfabético

Alpes 	Pág. 30	Paisaje 	Pág. 26
Atlantis 	Pág. 34	Prisma 	Pág. 34
<i>Novedad</i> Ebro 	Pág. 26	Prisma frontal 	Pág. 35
Génova 	Pág. 33	Royal 	Pág. 31
Horizonte 	Pág. 33	Servicios 	Pág. 27
Lago 	Pág. 27	Teide 	Pág. 29
Londres 	Pág. 30	Venus 	Pág. 28

Indice por páginas

Ebro	Pág. 26	Alpes	Pág. 30
Paisaje	Pág. 26	Royal	Pág. 31
Servicios	Pág. 27	Génova	Pág. 33
Lago	Pág. 27	Horizonte	Pág. 33
Venus	Pág. 28	Atlantis	Pág. 34
Teide	Pág. 29	Prisma	Pág. 34
Londres	Pág. 30	Prisma frontal	Pág. 35

EBRO



60464



A
OPCIÓN GRABADO

A
OPCIÓN GRABADO HUECO

Uds.	Cod.	Cod.	€
de 1 a 3 caracteres	10431	10433	5,90
de 4 a 10 caracteres	10432	10434	7,40

* Mínimo 20 buzones

Puertas de 1,5 mm. en aluminio anodizado o pintado con bocacartas en aluminio anodizado. Cuerpo de acero pintado en negro. El frontal desmontable le permite reparar o redecorar sus buzones fácilmente.

Cerradura Grado 1 según normativa EN-13724.

Novedad



Colores personalizados
Ver pág. 82



323 x 30 mm.

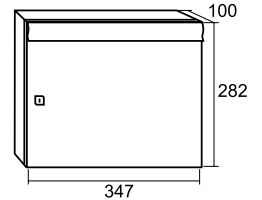

Colores Cuerpo/puerta	Cód.	€
Negro / Blanco	11240	45,00
Negro / Negro	11241	45,00
Negro / Aluminio	11242	48,00
Uds./caja	5	

✓ Stock permanente: envío garantizado en 24 horas

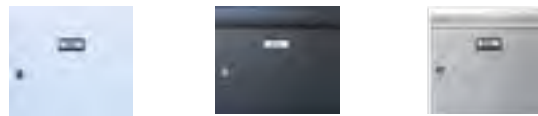

PAISAJE



60461



Colores personalizados
Ver pág. 82



250 x 30 mm.

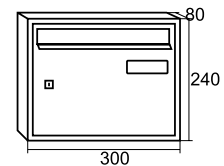

Colores Cuerpo/puerta	Cód.	€
Blanco / Blanco	03814	23,00
Negro / Negro	03820	23,00
Negro / Arena perla	03808	26,00
Negro / Plata	03829	25,50
Titanio / Titanio	03825	26,00
Uds./caja	12	

✓ Stock permanente: envío garantizado en 24 horas



Cuerpo de acero pintado en negro, excepto modelos en color blanco y titanio, puerta en acero pintado.

Cerradura Grado 1 según normativa EN-13724.

SERVICIOS



Cuerpo de acero pintado en negro excepto modelo en color blanco y plata. Puerta de acero pintado y acero inoxidable. Buzón de gran capacidad, ideal como buzón individual de sugerencias.

Cerradura Grado 1 según normativa EN-13724.



250 x 30 mm.

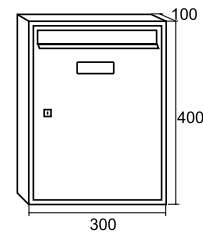

Colores Cuerpo/puerta	Cód.	€
✓ Blanco / Blanco	05704	33,35
✓ Negro / Negro	05712	33,35
✓ Negro / Acero Inox.	05710	42,75
✓ Plata	05711	36,35
Uds./caja	8	

✓ Stock permanente: envío garantizado en 24 horas



LAGO

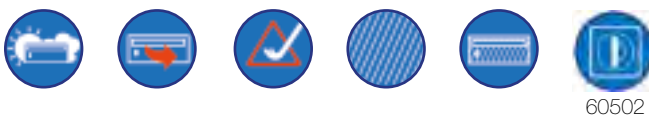

Cuerpo en aluminio negro y puerta de aluminio de 2,5 mm. de espesor. Este buzón, de gran capacidad es antivandálico y de alta resistencia.



237 x 32 mm.

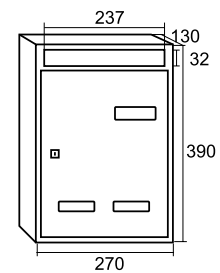

Colores Cuerpo/puerta	Cód.	€
Blanco / Blanco	05724	86,50
Negro / Aluminio natural	05722	86,50
Uds./caja	6	



VENUS



60450



Colores personalizados
Ver pág. 82



207 x 30 mm.

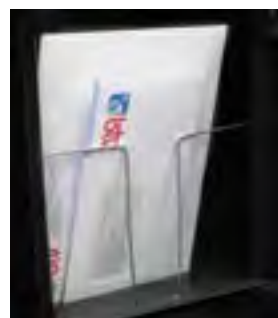
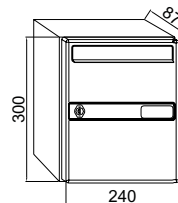

Soporte anticaída.



	Colores Cuerpo / Puerta	Cód.	€
✓	Negro / Inox. brillo	14407	28,10
	Negro / Inox mate	14406	28,60
✓	Blanco / Blanco	14414	18,50
	Negro / Negro	14420	18,50
✓	Negro / Arena perla	14409	20,50
	Negro / Magma	14424	21,50
	Negro / Oro	14405	20,50
✓	Negro / Plata	14426	20,50
	Uds./caja	12	

✓ Stock permanente: envío garantizado en 24 horas



TEIDE



60457

Cuerpo de acero pintado en negro excepto modelos en color blanco y plata. Puertas en acero pintado, skimplate y acero inoxidable (calidad AISI 304).

Cerradura Grado 1 según normativa EN-13724.



Colores personalizados
Ver pág. 82



198 x 24 mm.

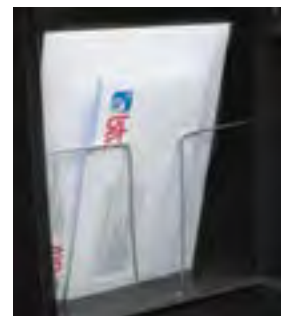
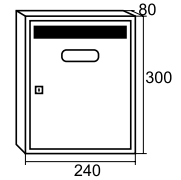

Soporte anticaída.



Colores		Cód.	€
Cuerpo / Puerta			
✓	Negro / Inox. brillo	05866	23,40
	Blanco / Blanco	05874	17,00
✓	Negro / Negro	05820	17,00
	Negro / Arena perla	05869	19,00
✓	Negro / Magma	15824	19,00
✓	Negro / Oro	05865	19,00
	Plata / Plata	05828	19,50
✓	Negro / Skimplate	05863	20,00
Uds./caja		12	

✓ Stock permanente: envío garantizado en 24 horas



LONDRES





60441

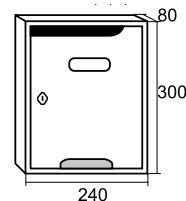

190 x 22 mm.



Colores Cuerpo / Puerta	Cód.	€
 Negro / Pino Oregón	06624	33,15
 Negro / Roble	06611	33,15
 Negro / Sapelli	06626	33,15
Uds./caja	12	



ALPES



madera 60448
inox 60449



222 x 28 mm.

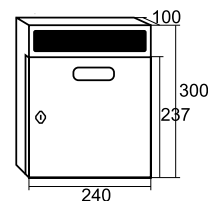

Colores Cuerpo / Puerta	Cód.	€
 Negro / Inox. brillo	16866	28,60
 Negro / Cerezo	06862	25,25
 Negro / Haya	06861	25,25
 Negro / Nogal oscuro	06863	25,25
Uds./caja	6	

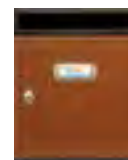
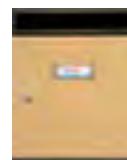

ROYAL



60442





Cuerpo de acero pintado en negro y puertas en chapeados de madera barnizada. Grueso de puerta 13 mm.

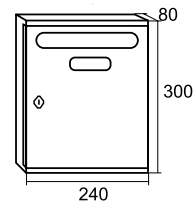

210 x 23 mm.



Colores		Cód.	€
Cuerpo / Puerta			
✓ 	Negro / Cerezo	06652	35,30
✓ 	Negro / Pino Oregón	06653	35,30
✓ 	Negro / Sapelli	06651	35,30
Uds./caja		12	

✓ Stock permanente: envío garantizado en 24 horas

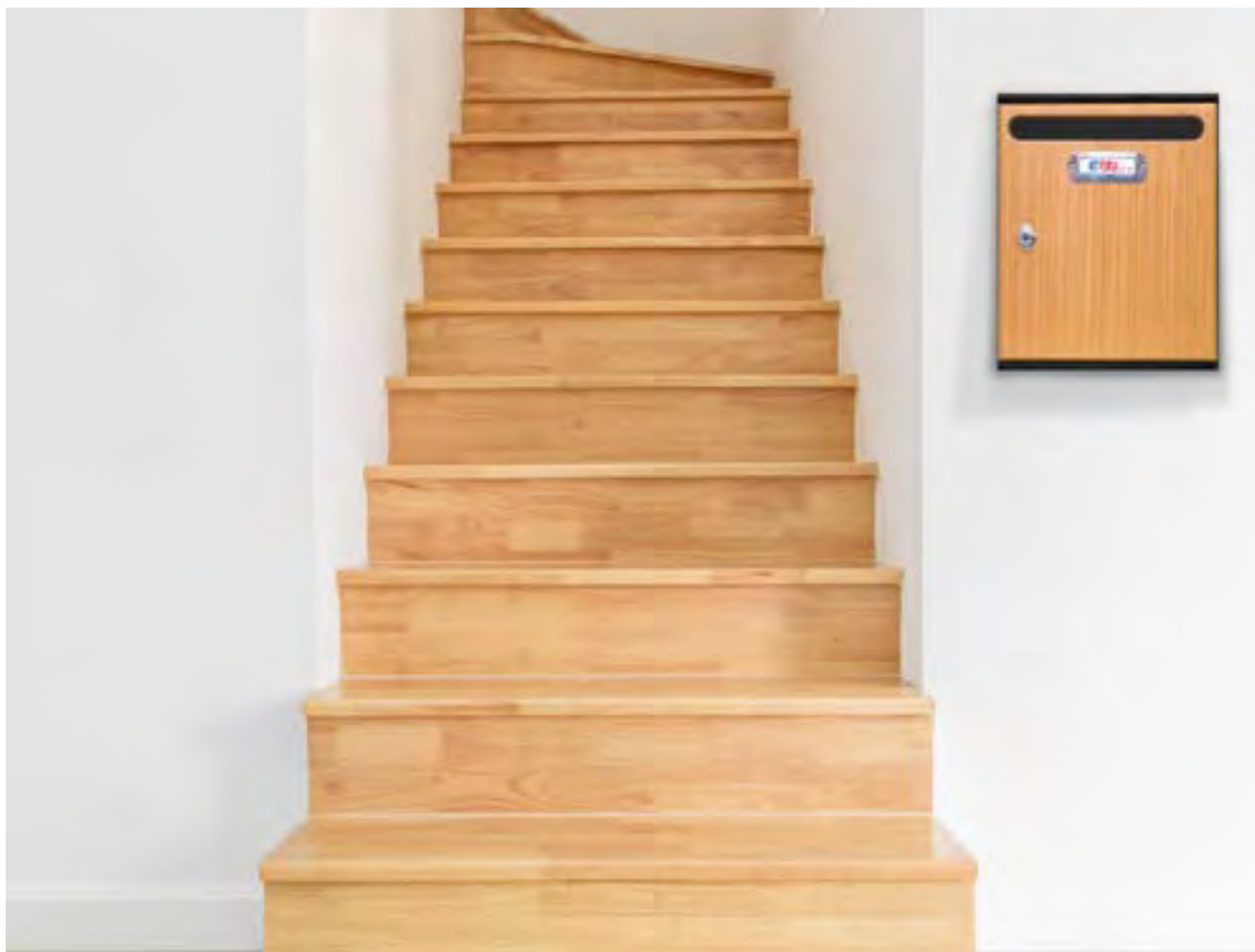
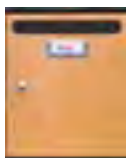



GÉNOVA





60502

Acero galvanizado pintado en grafito.
Cerradura Grado 1 según normativa EN-13724.

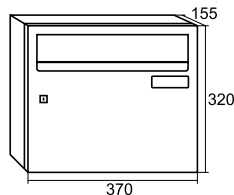

322 x 33 mm.



Colores	Cód.	€
✓  Grafito	02746	95,00
Uds./caja		1

✓ Stock permanente: envío garantizado en 24 horas



HORIZONTE





60468

Cuerpo y puerta en aluminio anodizado natural.
Cerradura Grado 1 según normativa EN-13724.

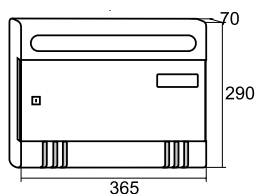

334 x 22 mm.



Colores	Cód.	€
✓  Anodizado natural	06902	38,50
Uds./caja		4

✓ Stock permanente: envío garantizado en 24 horas



PRISMA



60455



243 x 23 mm.

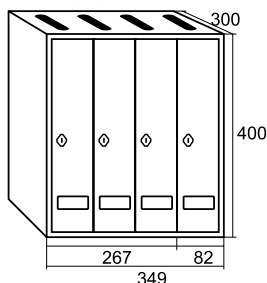

Cuerpo de acero pintado en negro excepto en modelo inoxidable brillo completo. Puerta de acero inoxidable brillo o acero pintado. Cuerpo en negro o acero inoxidable brillo (calidad AISI 304). Diseño, confort y originalidad. **Cerradura Grado 1 según normativa EN-13724.**

Colores personalizados
Ver pág. 82



Colores Cuerpo / Puerta	Cód.	€	Cód.	€
✓ Negro / Acero inox.	36106	97,50	46106	130,00
✓ Entero Acero Inox. brillo	36130	173,50	46130	231,30
Negro / Arena	36109	84,40	46109	112,50
Negro / Magma	36111	84,40	46111	112,50
Negro / Plata	36129	84,40	46129	112,50

✓ Stock permanente: envío garantizado en 24 horas



ATLANTIS



60465



250 x 30 mm.

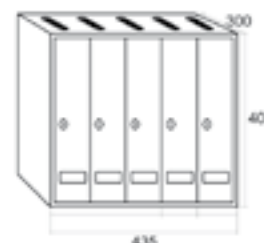
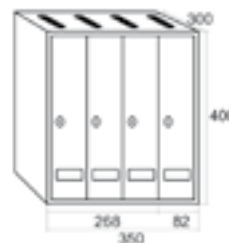

Cuerpo en acero pintado negro y puerta de aluminio anodizado natural. Disponibles en grupos de 4 y de 5 unidades.

Cerradura Grado 1 según normativa EN-13724.



Colores Cuerpo / Puerta	Cód.	€	Cód.	€
✓ Negro / Aluminio natural	41207	124,00	41208	156,00

✓ Stock permanente: envío garantizado en 24 horas



PRISMA FRONTAL

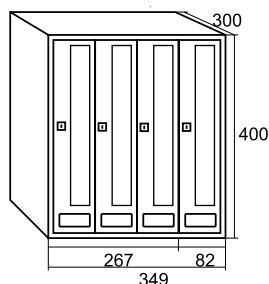
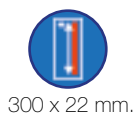

Cuerpo de acero pintado en negro excepto el modelo inoxidable brillo completo. Puerta en acero inoxidable brillo o acero pintado. Cuerpo en negro o inoxidable brillo (calidad AISI 304). **Cerradura Grado 1 según normativa EN-13724.**

 Colores personalizados
Ver pág. 82



Colores		Cód.	€	Cód.	€
Cuerpo / Puerta					
✓	Negro / Acero inox.	36310	97,50	46310	130,00
✓	Entero Acero Inox. brillo	36330	173,50	46330	231,30
	Negro / Arena	36309	84,40	46309	112,50
	Negro / Magma	36311	85,90	46311	112,50
	Negro / Plata	36328	85,90	46328	112,50





✓ Stock permanente: envío garantizado en 24 horas





BUZONES COMUNIDADES ESPECIAL MADERA

Indice alfabético

Astún		Pág. 39	Támesis		Pág. 41
Bruselas		Pág. 41	Toledo		Pág. 38
Dinamarca		Pág. 40	Acabados		Pág. 42
Niza		Pág. 38	Opciones		Pág. 42
Ronda		Pág. 39	Otros modelos		Pág. 43

Indice por páginas

Niza	Pág. 38
Toledo	Pag. 38
Astún	Pág. 39
Ronda	Pag. 39
Dinamarca	Pág. 40
Bruselas	Pág. 41
Támesis	Pag. 41
Acabados	Pág. 42
Opciones	Pág. 42
Otros modelos.....	Pág. 43

TOLEDO



60425



Cuerpo en melamina y puerta de acero pintado o acero inoxidable brillo. El cuerpo se puede fabricar en cualquier terminación de melaminas y maderas barnizadas (pág. 42).



325 x 23 mm.

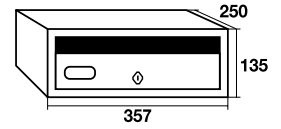

Colores		Cód.	€
Cuerpo	Puerta		
Roble	Inox. Brillo	02981	43,50
Roble	Titanio	02983	39,40
Wengé	Inox. Brillo	02984	43,50
Wengé	Titanio	02986	39,40

* Para muebles inferiores a 4 unidades tienen un suplemento del 50% sobre precio de venta.

** En agrupaciones mínimas de 4.

NIZA



60442



Cuerpo y puerta en madera barnizada.



265 x 23 mm.

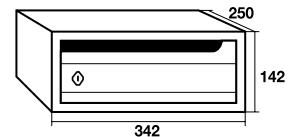

195 x 23 mm.

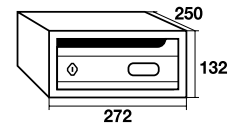

medidas	142 x 342 x 250		132 x 272 x 250	
Colores	Cód.	€	Cód.	€
Cerezo	16813	49,90	06805	43,60
Pino Oregón	16812	46,50	06804	42,35
Roble	16815	49,90	06803	43,60
Sapelli	16814	46,50	06806	42,35

Suplemento precio cambio de medidas.

Cod.	Ancho	Alto	Fondo
Cod.	99987	99990	99986
PVP €	5,60	7,00	5,60

RONDA



60442



Cuerpo y puerta en melamina.
Cantos redondeados y puerta curvada.

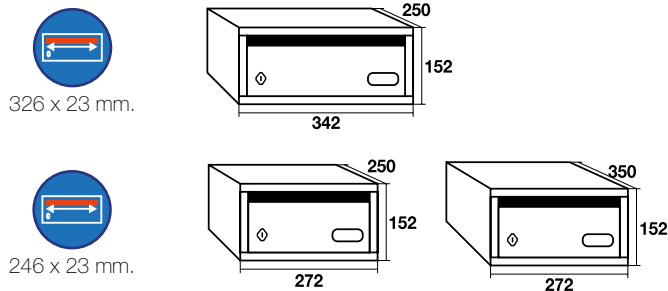

medidas	152 x 342 x 250		152 x 272 x 250		152 x 272 x 350		
Colores	Cód.	€	Cód.	€	Cód.	€	
	Bubinga	06423	48,95	06426	43,35	06429	48,95
	Haya	06421	48,95	06424	43,35	06427	48,95
	Roble	06422	48,95	06425	43,35	06428	48,95

* Los precios indicados corresponden a un buzón.
** En agrupaciones mínimas de 4.

Suplemento precio
cambio de medidas.

Cod.	Ancho	Alto	Fondo
Cod.	99987	99990	99986
PVP €	5,60	-	5,60

ASTÚN



60442



Cuerpo y puerta en madera laminada y cantos redondeados.

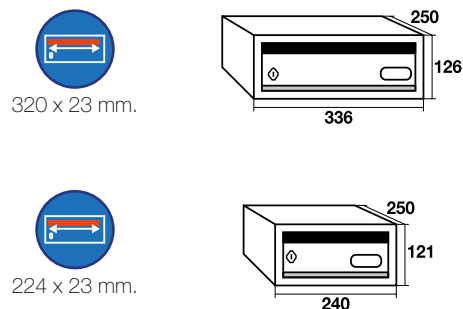

medidas	126 x 336 x 250		121 x 240 x 250		
Colores	Cód.	€	Cód.	€	
	Haya Astún	06521	38,20	06514	34,40
	Roble Astún	06519	38,20	06516	34,40
	Sapelli	06518	38,20	06517	34,40
	Wengué	06520	38,20	06515	34,40

Suplemento precio
cambio de medidas.

Cod.	Ancho	Alto	Fondo
Cod.	99987	99990	99986
PVP €	5,60	-	-

DINAMARCA



60442



316 x 23 mm.

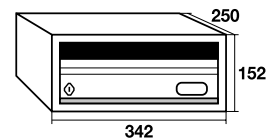

246 x 23 mm.

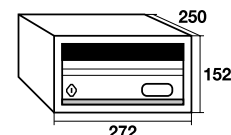

medidas		152 x 342 x 250		152 x 272 x 250	
Colores		Cód.	€	Cód.	€
	Bubinga	06406	40,70	06556	38,50
	Cerezo	06405	40,70	06555	38,50
	Haya	16557	40,70	16558	38,50
	Roble	06404	40,70	06554	38,50

Suplemento precio cambio de medidas.

Cod.	Ancho	Alto	Fondo
Cod.	99987	99990	99986
PVP €	5,60	-	5,60

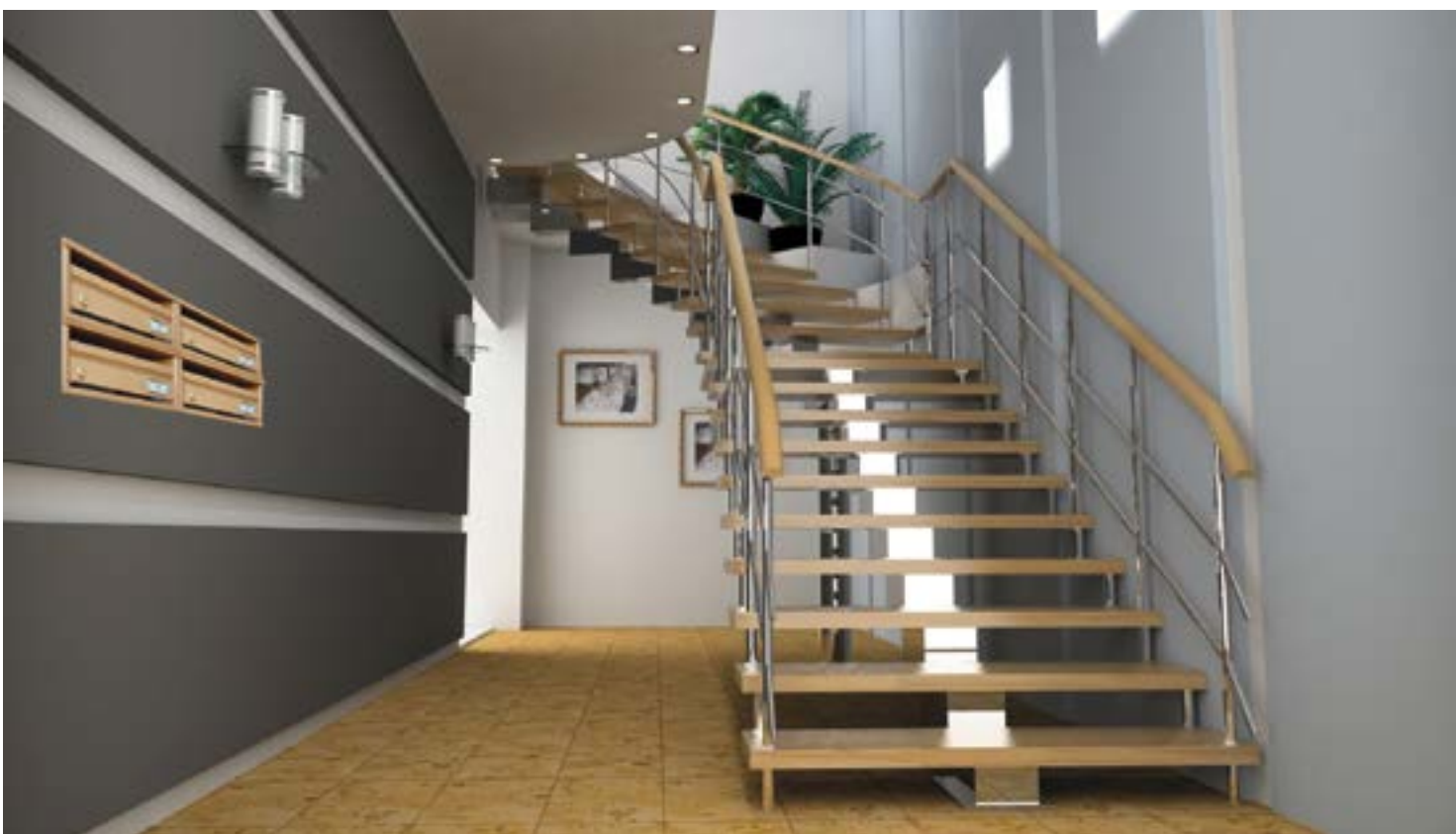

Cuerpo en melamina y puerta en madera laminada con cantos redondeados.

TÁMESIS



60442



Cuerpo y puerta en madera barnizada.



195 x 23 mm.

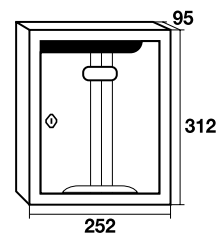

Colores	Cód.	€
Cerezo	06705	46,90
Pino Oregón	06704	46,90
Roble	06703	46,90
Sapelli	06706	46,90

* Los precios indicados corresponden a un buzón.

Suplemento precio cambio de medidas.

Cod.	Ancho	Alto	Fondo
Cod.	99987	99990	99986
PVP €	5,60	-	5,60

BRUSELAS



60442



Cuerpo en melamina con cantos redondeados y puerta en madera barnizada y laminada.



230 x 23 mm.

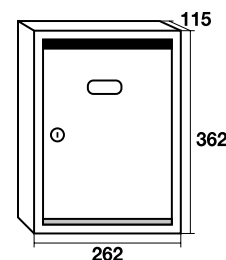

Colores	Cód.	€
Puerta madera laminada		
Bubinga	06302	58,00
Puerta madera barnizada		
Cerezo	06305	58,00
Haya	06306	58,00
Roble natural	06303	58,00

* Los precios indicados corresponden a un buzón.

Suplemento precio cambio de medidas.

Cod.	Ancho	Alto	Fondo
Cod.	99987	99990	99986
PVP €	5,60	7,00	-

Acabados

HORIZONTAL VERTICAL METÁLICO MADERA COMUNIDAD

MELAMINAS

Melaminas en diferentes acabados



Sapelli Roble Cerezo Nogal Oscuro Nogal Claro Haya Catania Haya Astún



Roble Astún Wengé Haya Bubinga Roble Ceniza Acacia

MADERAS BARNIZADAS

Chapeado de madera barnizado



Sapelli Bubinga Roble natural Haya Embero Embero teñido nogal



Sapelli teñido caboba Pino Oregón Cerezo Roble Wengé

Soportes para agrupaciones



PATAS (incluyen trasera de apoyo)		
Modelo	Cód.	€
Melamina		
Pareja de patas de 700	10620	140,50
Pareja de patas de 850	10621	156,00
Pareja de patas de 1000	10622	172,00
Madera		
Pareja de patas de 700	10623	187,50
Pareja de patas de 850	10624	203,00
Pareja de patas de 1000	10625	219,00
Baldas		
Metro lineal balda melamina	10626	28,00
Metro lineal balda madera	10627	44,00

Conjunto de soportes para agrupaciones de buzones, en melamina o madera. Misma terminación que los buzones. Con balda de madera para publicidad.

Otros modelos disponibles



GRECIA



ARANJUEZ



GANTE



HÉRCULES



IMPERIO



EUROPA



ESTAFETA



VENECIA

ALTURA DEL CONJUNTO	-	1176	-	-	-	-	-	-	-	-	-
	-	1060	1240	-	1240	-	-	-	-	-	-
	877	944	1104	917	1104	968	1024	-	-	-	-
	769	828	968	804	968	849	898	-	-	-	-
	661	712	832	691	832	730	772	-	-	-	-
	553	596	696	578	696	611	646	-	-	-	-
	445	480	560	465	560	492	520	1400	1200	-	-
	337	364	424	352	424	373	394	1054	904	-	-
	229	248	288	239	288	254	268	708	608	-	-
	121	132	152	126	152	135	142	362	312	-	-

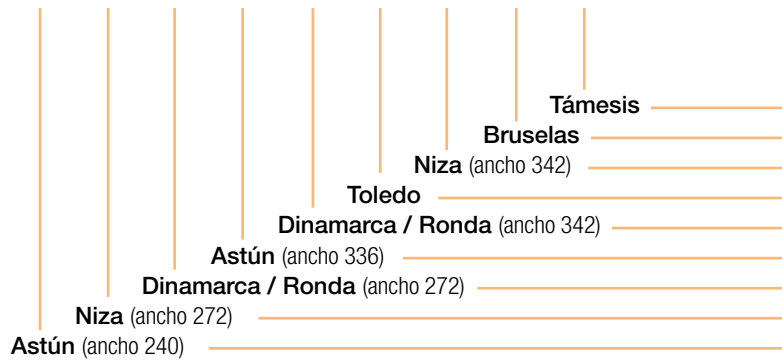

NUMERO DE UNIDADES POR CONJUNTO

10	20	30	40	50	60	70	80
9	18	27	36	45	54	63	72
8	16	24	32	40	48	56	64
7	14	21	28	35	42	49	56
6	12	18	24	30	36	42	48
5	10	15	20	25	30	35	40
4	8	12	16	20	24	28	32
3	6	9	12	15	18	21	24
2	4	6	8	10	12	14	16
1	2	3	4	5	6	7	8

252	488	724	960	1196	1432	1668	1904
262	508	754	1000	1246	1492	1738	1984
342	668	994	1320	1646	1972	2298	-
357	698	1039	1380	1721	-	-	-
342	668	994	1320	1646	1972	2298	-
336	659	982	1305	1628	1951	-	-
272	528	784	1040	1296	1552	1808	2064
272	528	784	1040	1296	1552	1808	2064
240	467	694	921	1148	1375	1602	1829

ANCHO DEL CONJUNTO



BUZONES INDIVIDUALES EXTERIOR

✓ Disponemos de stock permanente de todos nuestros buzones individuales. Envío garantizado en 24 h

Índice alfabético

Plástico

Novedad
Galaxy  Pág. 46

Garden  Pág. 47

Ibiza  Pág. 47

Mallorca  Pág. 46

Acero

Berlín acero  Pág. 54

Castillo  Pág. 50

Chalet  Pág. 49

Colonia  Pág. 49

Cortijo  Pág. 50

Novedad
Dakota acero  Pág. 52

Góndola acero  Pág. 55

Novedad
Lisboa acero  Pág. 53

Logo  Pág. 51

Nano acero  Pág. 54

Posta  Pág. 55

Riviera  Pág. 51

Acero Inoxidable

Berlín inox  Pág. 59

Forja  Pág. 59

Góndola inox  Pág. 57

Lisboa inox  Pág. 58

Novedad
Nano inox  Pág. 58

Tokyo  Pág. 57

Aluminio

Alhambra  Pág. 61

Dakota aluminio  Pág. 63

Ibiza aluminio  Pág. 62

Imperial  Pág. 61

Índice por páginas

Galaxy Pág. 46
Mallorca..... Pág. 46
Ibiza Pág. 47
Garden Pág. 47
Chalet..... Pág. 49
Colonia..... Pág. 49
Castillo Pág. 50
Cortijo Pág. 50
Riviera Pág. 51

Logo..... Pág. 51
Dakota acero Pág. 52
Lisboa acero..... Pág. 53
Nano acero Pág. 54
Berlín acero Pág. 54
Góndola acero..... Pág. 55
Posta..... Pág. 55
Góndola inox..... Pág. 57
Tokio Pág. 57

Lisboa inox..... Pág. 58
Nano inox..... Pág. 58
Berlín inox..... Pág. 59
Forja..... Pág. 59
Alhambra..... Pág. 61
Imperial Pág. 61
Ibiza aluminio..... Pág. 62
Dakota aluminio..... Pág. 63

GALAXY



60465



Preparado para bocacartas en su parte trasera.

Buzón de exterior, fabricado en PVC de gran resistencia y amplia gama de colores. Peso: 1,4 Kg.

La puerta se detiene a 45° para alojar la correspondencia.

Preparado para bocacartas en su parte trasera.

Cerradura Grado 1 según normativa EN-13724.

Novedad



245 x 30 mm.

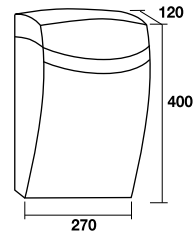

Colores	Cód.	Cód EAN 8421461	€
	12740	127402	26,90
	12741	127419	26,90
	12743	127433	26,90
	12742	127426	26,90
	12744	127440	26,90
Uds./caja	5		



MALLORCA



60408



210 x 20 mm.
Frontal



240 x 30 mm.
Superior

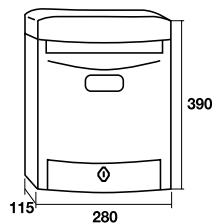

Cuerpo y puerta construido en ABS de alta resistencia. Trasera metálica, galvanizada, pintada. Doble entrada de cartas, superior para correspondencia voluminosa y frontal. Peso 1,7 Kg.

Colores	Cód.	Cód EAN 8421461	€
	02920	029201	29,10
	02921	029218	29,10
	02923	029232	29,10
	02922	029225	29,10
Uds./caja	8		



IBIZA



60408

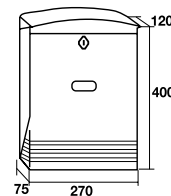

Colores	Cód.	Cód EAN 8421461	€
	02940	029409	30,80
	02944	029447	30,80
	02942	029423	30,80
Uds./caja	9		



Bocacartas ver pág. 71



GARDEN

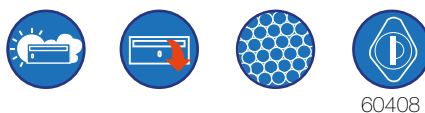

60408

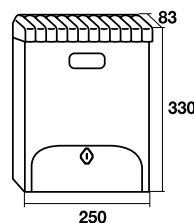

Colores	Cód.	Cód EAN 8421461	€
	02930	029300	17,55
	02931	029317	17,55
	02933	029331	17,55
	02932	029324	17,55
Uds./caja	8		



Cuerpo y puertas fabricadas en ABS de alta resistencia. Se adapta a todos los climas, y está disponible en 3 colores. **Preparado para bocacartas en su parte trasera.** Peso: 1,6 Kg.

Cuerpo y puerta en resina de alta resistencia. La puerta de entrega de cartas está diseñada con forma de tejadillo. Peso 1 kg.



CHALET



Soporte anticaída

Construidos en acero galvanizado y pintado. Es un buzón resistente y muy decorativo con gran éxito en el mercado. Peso 2 Kg. **Cerradura Grado 1 según normativa EN-13724.**

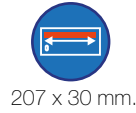

207 x 30 mm.

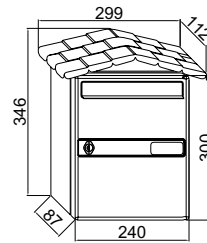

Colores	Cód.	Cód EAN 8421461	€
	02110	021106	25,20
	02111	021113	25,20
	02112	021120	25,20
	02101	021014	25,20
Uds./caja	8		



COLONIA



Soporte anticaída



203 x 28 mm.

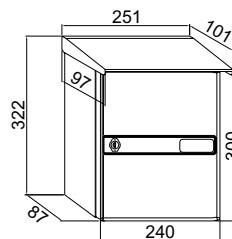

Construidos en acero galvanizado y pintado. Peso: 1,9 Kg. **Cerradura Grado 1 según normativa EN-13724.**

Colores	Cód.	Cód EAN 8421461	€
	02210	022103	24,70
	02211	022110	24,70
	02212	022127	24,70
	02201	022011	24,70
Uds./caja	10		



CASTILLO



60461



Construidos en acero pintado en poliéster. Líneas clásicas, resistencia y gran capacidad. Peso 3,1 Kg.

Preparado para bocacartas en su parte trasera
Cerradura Grado 1 según normativa EN-13724.



250 x 32 mm.

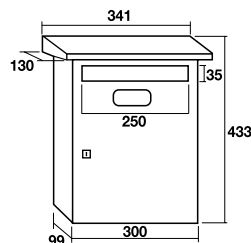

255 x 28 mm.



Bocacartas ver pág. 71

Colores	Cód.	Cód EAN 8421461	€
	01810	018106	40,70
	01811	018113	40,70
	01801	018014	40,70
Uds./caja	6		



CORTIJO



60469

Construidos en acero galvanizado pintado en poliéster. Peso: 2,8 kg.

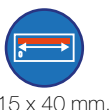

215 x 40 mm.

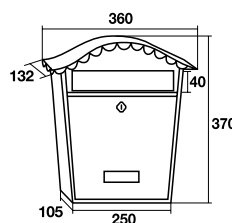

Colores	Cód.	Cód EAN 8421461	€
	02010	020109	22,00
	02011	020116	22,00
	02012	020123	22,00
	02001	020017	22,00
Uds./caja	5		



RIVIERA

Acero galvanizado pintado blanco. Incluye macetero PVC y pegatinas decorativas. Estante portamacetero plegable. Peso 2,8 kg. **Cerradura Grado 1 según normativa EN-13724.**



60461



325 x 35 mm.

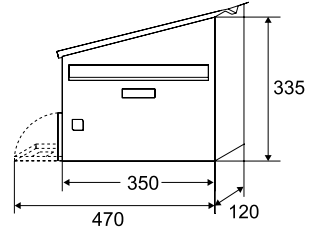

Colores	Cód.	Cód EAN 8421461	€
Blanco	12750	127501	37,50
Uds./caja		3	



LOGO

Acero galvanizado pintado negro (cuerpo) y acero inoxidable en puerta y bocacartas (calidad Inox 21CT). Peso 2,5 Kg. **Cerradura Grado 1 según normativa EN-13724.**



60455

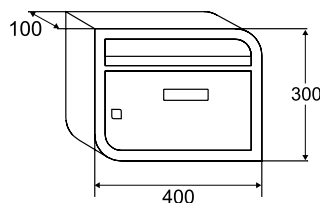

365 x 35 mm.

Colores Cuerpo / Puerta	Cód.	Cód EAN 8421461	€
Negro / Ac. Inoxidable	12760	127600	45,00
Uds./caja		4	



DAKOTA acero



Novedad



Construido en acero galvanizado y acanalado para mayor resistencia y durabilidad. Soporte formado por dos partes de acero que se arman para alcanzar la altura de 152,4 cm. Peso: 1,75 kg.

Diseño mejorado

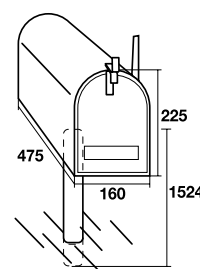

Soporte buzón

Colores	Cód.	Cód EAN 8421461	€
Negro	66112	661128	35,00
Rojo	66099	660992	35,00
Verde	66111	661111	35,00
Uds./caja		5	
Soporte buzón	66098	660985	18,50

Diámetro 4 cms. Alto 75 cm + 70 cm (Para anclar al suelo)

LISBOA acero



Novedad



Modelo	Horizontal			Vertical		
Colores	Cód.	Cód EAN 8421461	€	Cód.	Cód EAN 8421461	€
Blanco	11197	111975	28,00	11183	111838	26,50
Negro	11198	111982	28,00	11184	111845	26,50
Verde	11199	111999	28,00	11185	111852	26,50
Uds./caja	5					



Construidos en acero galvanizado pintado.
Gran capacidad con diseño contemporáneo.
Peso: 1,8 kg.



300 x 30 mm.



230 x 25 mm.

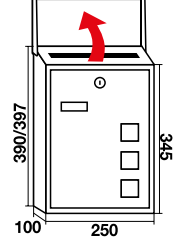
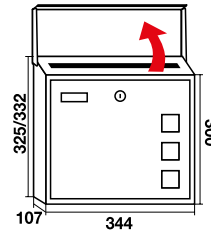

NANO acero



60471

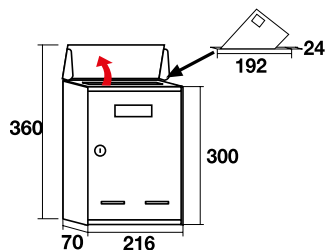

Colores	Cód.	Cód EAN 8421461	€
	12710	127105	19,45
	12711	127112	19,45
Uds./caja		10	



BERLÍN acero



60469

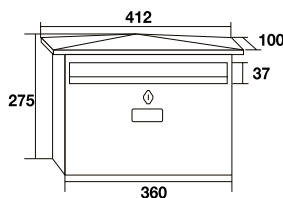

Colores	Cód.	Cód EAN 8421461	€
	02183	021830	21,00
	02184	021847	21,00
	02181	021816	21,00
Uds./caja		6	



Acero galvanizado pintado. Líneas rectas y contemporáneas en dimensiones compactas. Peso 1,3 kg.

Buzón de exterior fabricado en acero galvanizado pintado. Peso: 1,81 kg.

GÓNDOLA acero



Construidos en acero galvanizado pintado. Peso: 2,2 kg. **Cerradura Grado 1** según normativa EN-13724.



325 x 30 mm.

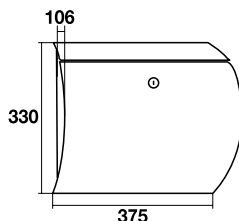

Colores	Cód.	Cód EAN 8421461	€
	10671	106711	45,00
	10672	106728	45,00
	10673	106735	45,00
Uds./caja		5	



POSTA acero



Construidos en acero galvanizado pintado. Peso: 1,1 kg. **Cerradura Grado 1** según normativa EN-13724.



180 x 25 mm.

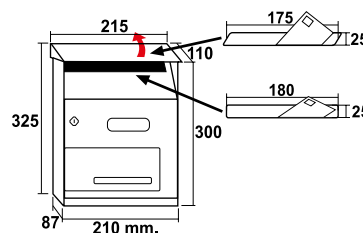

Colores	Cód.	Cód EAN 8421461	€
	02749	1027498	23,20
	02750	1027504	23,20
Uds./caja		5	





GÓNDOLA^{inox}

Construidos todos en acero inoxidable mate.
Acero inoxidable calidad 304. Peso: 2,2 kg.
Cerradura Grado 1 según normativa EN-13724.



60462



325 x 30 mm.

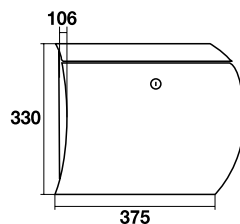

Colores	Cód.	Cód EAN 8421461	€
Inox mate	02030	020307	57,00
Uds./caja	5		



TOKYO

Fabricado en acero inoxidable pintado o en acero inoxidable.
Acero inoxidable calidad 304. Peso: 1,5 kg.
Cerradura Grado 1 según normativa EN-13724.



60462



252 x 47 mm.

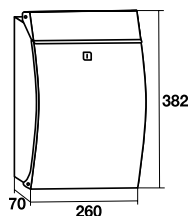

300 x 30 mm.

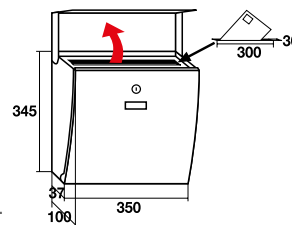

Colores		Vertical			Horizontal		
Puerta	Cuerpo	Cód.	Cód EAN 8421461	€	Cód.	Cód EAN 8421461	€
Inox. mate	Inox. mate	12606	126061	44,30	12614	126146	48,40
Acero inox. pintado blanco	Acero inox. pintado blanco	12610	126108	46,35	12615	126153	50,45
Acero inox. pintado negro	Acero inox. pintado negro	12611	126115	46,35	12616	126160	50,45
Acero inox. pintado negro	Acero inox. pintado blanco	12613	126139	46,35	-	-	-
Acero inox. pintado rojo	Acero inox. pintado blanco	12612	126122	46,35	12617	126177	50,45
Uds./caja				5			



LISBOA inox



60469



Construidos en acero inoxidable mate. Gran capacidad con diseño contemporáneo. Acero inoxidable calidad 304
Peso: 1,8 kg.

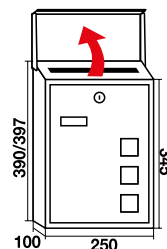
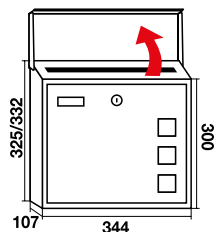

Modelo	Cód.	Cód EAN 8421461	€
Inox. mate horizontal	11196	111968	39,90
Inox. mate vertical	11186	111869	45,50
Uds./caja	5		

NANO inox



60471

Acero inoxidable. Líneas rectas y contemporáneas en dimensiones compactas. Acero inoxidable calidad 304.
Peso 1,3 kg.

Novedad

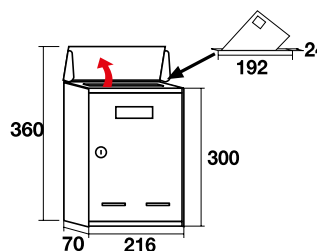
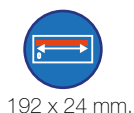

Colores	Cód.	Cód EAN 8421461	€
Acero inoxidable	12720	127204	29,90
Uds./caja	6		

* Disponible a partir de Enero 2015

BERLÍN inox



320 x 35 mm.

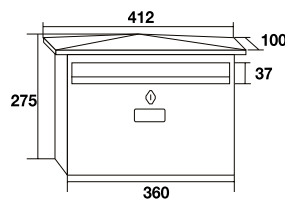

Colores	Cód.	Cód EAN 8421461	€
Inox. mate	02182	021823	44,50
Uds./caja			5



Buzón de exterior fabricado en acero inoxidable. Acero inoxidable calidad 304. Peso: 1,81 kg.

FORJA



Detalle de apertura mod. 2

Construidos en acero inoxidable pintado y decorado.

1



218 x 25 mm.
Peso: 1,8 Kg.

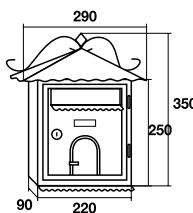

2



248 x 25 mm.
Peso: 2,1 Kg.

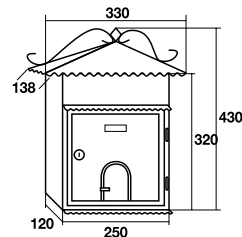

Colores	Cód.	Cód EAN 8421461	€
1 Acero inoxidable (mod.1)	02772	027726	38,60
2 Acero inoxidable (mod.2)	02773	027733	46,80
Uds./caja	Cód. 02772: 5	Cód. 02773: 4	



ALHAMBRA



60472



230 x 40 mm.

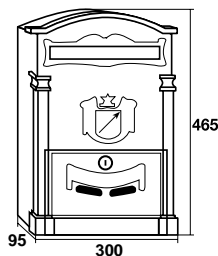

Colores	Cód.	Cód EAN 8421461	€
	02735	027351	44,00
	02736	027368	44,00
	02738	027382	44,00
Uds./caja	4		



IMPERIAL



60505



220 x 40 mm.

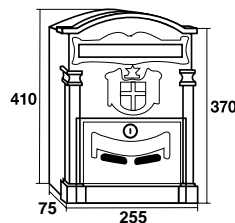

Colores	Cód.	Cód EAN 8421461	€
	02793	027931	31,00
	02794	027948	31,00
	02796	027962	31,00
Uds./caja	5		



Frontal de aluminio fundido y cuerpo de acero.
Elegancia y gran capacidad. Peso: 3 kg.

Frontal en aluminio fundido con cuerpo de acero. Con estilo neoclásico, el Imperial es un buzón apuesto y ligero. Peso: 3 kg.

IBIZA aluminio



Construido en aluminio inyectado de 3 mm. espesor. Alta resistencia, perfecto para exterior. Peso: 3 kg.



230 x 32 mm.

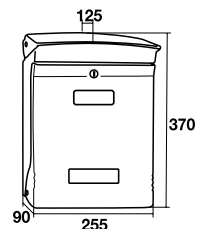

Colores		Cód.	Cód EAN 8421461	€
	Grafito	02949	029492	45,00
	Rojo	02948	029485	45,00
	Verde	02947	029478	45,00
Uds./caja				4



DAKOTA



Construido en aluminio y acanalado para mayor resistencia y durabilidad. Soporte formado por dos partes de acero que se arman para alcanzar la altura de 152,4 cm.
Peso: 1,75 kg.

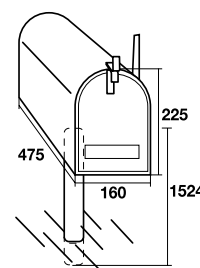

Soporte buzón

Colores	Cód.	Cód EAN 8421461	€
Aluminio natural	66110	661104	38,00
Uds./caja	5		
Soporte buzón	66098	660985	18,50

Diámetro 4 cms. Alto 75 cm + 70 cm (Para anclar al suelo)









BUZONES

INDIVIDUALES

PAQUETERÍA, DOBLE BOCA Y USOS ESPECIALES

Indice alfabético

Bocacartas		Pág. 71	Panera		Pág. 66
Casilleros		Pág. 69	<i>Novedad</i> Pack- Box		Pág. 67
Oslo		Pág. 68	Recoge cartas		Pág. 70

Indice por páginas

Panera.....	Pág. 66	Recoge cartas	Pág. 70
Pack- Box	Pág. 67	Bocacartas.....	Pág. 71
Oslo	Pág. 68		
Casilleros.....	Pág. 69		

PANERA



Serreta
60456



Puntos
111014



Pomo
111031

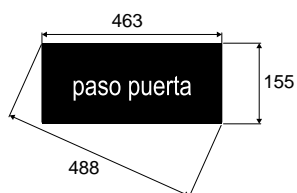
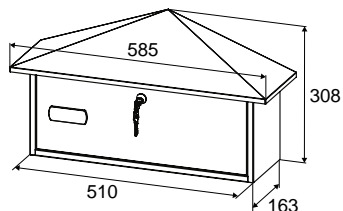

Buzón de exterior fabricado en acero galvanizado pintado en color blanco. Disponible en otros colores bajo pedido.

Diseñado para facilitar el reparto a domicilio de pan sin necesidad de que el usuario se encuentre en su domicilio.

Stock permanente en modelos con y sin amaestramiento.



Otros colores bajo pedido
mínimo 25 unidades

POMO AUTOMÁTICO

Así de **práctico**, así de **fácil**



El buzón panera está preparado para recibir entregas. Observe que el pomo sobresale de su cavidad.

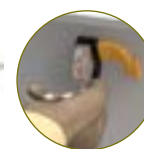

El repartidor puede abrir el buzón sin llave; sólo tiene que girar el pomo hacia la derecha.

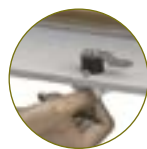

La amplia apertura de la puerta y capacidad del buzón panera, permite introducir los envíos fácilmente.



Para cerrar el buzón, el repartidor girará el pomo hacia la izquierda y lo empujará hacia dentro. Ahora ya no es posible abrir el buzón sin llave.



Cuando queramos recoger nuestro encargo, abriremos el buzón utilizando la llave particular.



Cerradura Serreta



Cerradura Puntos



Pomo Automático

Color / Cerradura	Cód.	€
Blanco / Serreta	10145	59,90
Blanco / Pomo automático	10144	69,90
✓ Blanco / Cerradura de puntos y amaestramiento	10147	73,00
Uds./caja	1	

✓ Stock permanente: envío garantizado en 24 horas

PACK - BOX



Novedad

Cada vez más personas descubren el comercio online y encargan el envío de sus compras a domicilio. Ahora el repartidor puede depositar los paquetes y dejarlos a buen recaudo. Una vez depositado el paquete, no se puede observar desde fuera si hay algo en el interior.

Los Pack-Box están contruidos en acero galvanizado y pintado y su cerradura grado I dispone de pestillo a tres lados.

Los buzones Pack-Box aseguran la buena recepción de los paquetes hasta tamaño 200x300x100 mm.



Tamaño de apertura para paquetes:
335x100 mm



Tamaño de apertura para cartas:
335x18,5 mm

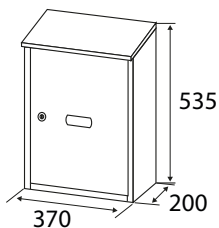

Cerradura de Grado I con 3 puntos de fijación

Colores	Cód.	€
✓ Grafito	02779	95,00
Uds./caja	1	

✓ Stock permanente: envío garantizado en 24 horas

OSLO



Buzón de gran capacidad. Incluye soporte para instalación sobre suelo, así como instalación a pared.
Acero galvanizado pintado. Peso: 9 kg.

Cerradura Grado 1 según normativa EN-13724.

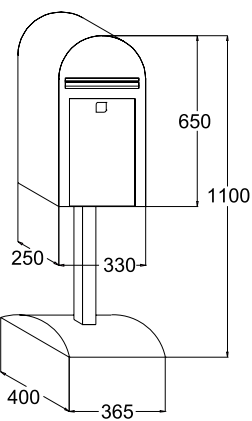

285 x 30 mm.



Colores	Cód.	€
Blanco	12770	124,00
Uds./caja	1	

✓ Stock permanente: envío garantizado en 24 horas

CASILLEROS

PARA ENTIDADES BANCARIAS



Se construyen en chapa de acero pintado en blanco.

Para empresas y entidades bancarias, disponemos de buzones y casilleros adecuados para dinero en efectivo, otros documentos y correspondencia.

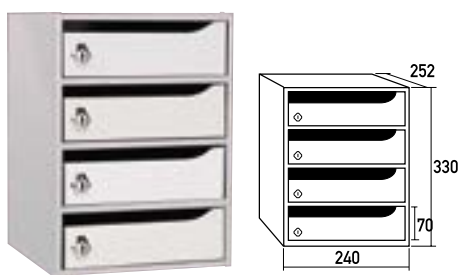

Modelo Tesoro

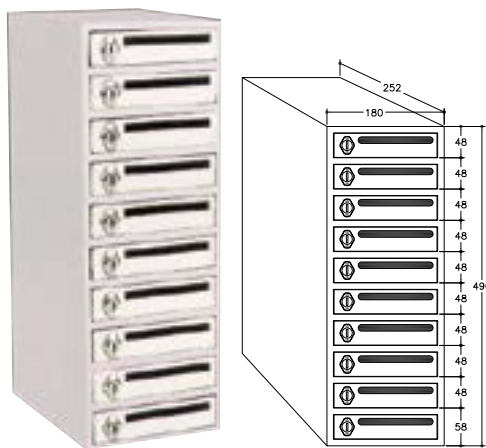

Modelo Cheque

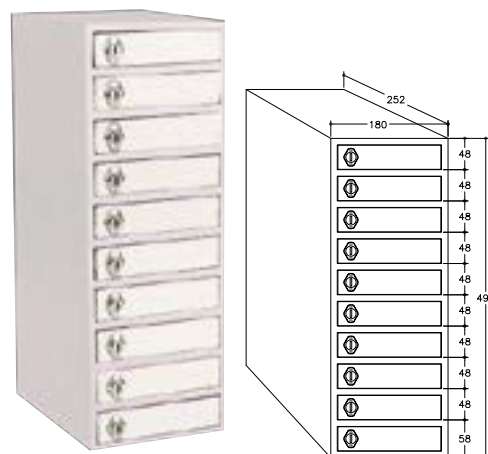

Modelo Cheque ciego



Ejemplo de Casilleros personalizados de acero inoxidable

Modelo	Cód.	€
Tesoro blanco (Grupos de 4)	70642	56,75
Cheque blanco (Grupos de 10)	70637	116,50
Cheque puerta ciega (Grupos de 10)	70635	116,50

* Pedido mínimo 10 grupos

RECOGE CARTAS



Construidos en chapa de acero pintada, o en acero inoxidable (calidad 304) brillo.
Cerradura Grado 1 según normativa EN-13724.





Vista interior acero inoxidable



Vista exterior acero con bocacartas



Soporte anticaída

Colores	Recoge cartas		KIT Bocacartas + recogecartas	
	Cód.	€	Cód.	€
✓  Ac. Inoxidable	00441	79,95	KIT4 10441	88,95
✓  Blanco	00442	42,50	KIT10 00414	55,00
✓  Negro	00443	42,50	KIT11 00415	55,00
Uds./caja			6	

✓ Stock permanente: envío garantizado en 24 horas



El bocacartas que se incluye en este kit, es el código 00401 (aluminio pintado plata)

BOCACARTAS

Construidos en aluminio pintado, latón envejecido y acero inoxidable.



- 

1



2



3



4



5



6

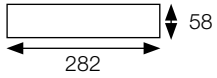

7
- 

282
58



250 X 27 mm.
 - 

282
58



250 X 27 mm.
 - 

282
58



250 X 27 mm.
 - 

282
58



250 X 27 mm.
 - 

282
58



250 X 27 mm.
 - 

290
74

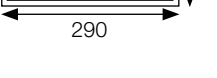

265 X 30 mm.
 - 

340
180



240 X 40 mm.



Incluye pegatina decorativa

	Colores	Cód.	€
✓ 1	Aluminio pintado plata	00401	16,25
✓ 2	Aluminio pintado dorado	66302	17,85
✓ 3	Aluminio pintado magma	66324	17,85
✓ 4	Aluminio pintado blanco	00410	16,25
✓ 5	Aluminio pintado negro	00411	16,25
✓ 6	Acero inoxidable mate	66300	24,50
✓ 7	Latón brillo	00450	108,65

✓ Stock permanente: envío garantizado en 24 horas



VILLAS DEL VALLE



EQUIPAMIENTO Y ACCESORIOS

Índice alfabético

Agrupaciones
y rotulación  **Pág. 74**

Cerraduras  **Pág. 85**

Colores
y acabados  **Pág. 82**

Envoltorios  **Pág. 76**

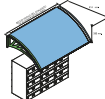
Marquesinas  **Pág. 80**

Soporte Anticaída  **Pág. 83**

Soportes  **Pág. 79**

Soportes y brazos  **Pág. 78**

Sujeta buzones
exterior  **Pág. 83**

Tapajuntas  **Pág. 77**

Tarjeteros  **Pág. 84**

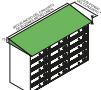
Tejados
Iluminación LED  **Pág. 81**

Índice por páginas

Agrupaciones y rotulación Pág. 74
Envoltorios Pág. 76
Tapajuntas Pág. 77
Soportes y brazos Pág. 78
Soportes Pág. 79
Marquesinas Pág. 80

Tejados - Iluminación LED Pág. 81
Colores y acabados Pág. 82
Soporte Anticaída Pág. 83
Sujeta buzones exterior Pág. 83
Tarjeteros Pág. 84
Cerraduras Pág. 85

TODAS LAS OPCIONES PARA EQUIPAR LAS AGRUPACIONES DE BUZONES



PASOS A SEGUIR PARA EL MONTAJE Y LA ROTULACIÓN DE AGRUPACIONES

- 1 Reparte el número de buzones entre filas y columnas:
Máximo 7 buzones horizontales en altura.
Máximo 3 buzones verticales en altura.
Recuerda que los buzones verticales con boca de entrada superior no se pueden superponer.
Ancho máximo total recomendado 2 m.
- 2 Cuenta los espacios para bandejas, placas de portero o anuncios que necesitará tu grupo de buzones.
- 3 Rotula la agrupación y aprovecha los huecos para anuncios y publicidad.
- 4 Selecciona los complementos para vestir la agrupación: envolvente, tapajuntas, soportes, tejado... BTV monta el conjunto y te lo envía listo para su instalación.

Máximo número de Buzones en altura



Horizontales

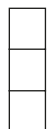

Verticales

Máximo ancho en conjuntos de buzones

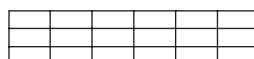

2 metros



Visita nuestra web www.btv.es y planifica de manera muy sencilla el diseño de tu conjunto de buzones.

ROTULACIÓN PARA AGRUPACIONES

Rotulación de vinilo sobre placa en conjunto de buzones. Personalización del bloque de buzones con la dirección, nombre de urbanización o polígono industrial.

Placas según terminación. Anchura máxima 2 metros.

Precios por metro lineal.

	Aluminio anodizado natural Cód. 10380 € 75,00
	Acero inoxidable brillo Cód. 10389 € 80,00
	Acero inoxidable mate Cód. 10385 € 80,00



Tipografías

Arial Narrow:	PLAZA DEL PILAR Nº 123
Eurostyle:	PLAZA DEL PILAR Nº 123
Times New Roman:	PLAZA DEL PILAR Nº 123

Medidas placa

Alto:	135 mm.
Ancho Máximo:	2.000 mm.
Precio:	Metro lineal.



HUECO PARA PORTANUNCIOS

Construidos con marco del buzón elegido Puerta de metacrilato con cerradura BTV.

Cod. 10286.

€: Por hueco de buzón 150% del valor total del buzón

HUECO PARA BANDEJAS PUBLICIDAD

Construidos con marco del buzón y fondo del envoltente.

Cod. 10285

De uno, dos o tres buzones de ancho.

€: 50% del valor total del buzón

Agrupación con rótulo de vinilo sobre placa de aluminio, acero pintado o inoxidable, con hueco anuncios y hueco dos bandejas.

MONTAJE DE AGRUPACIONES

Realizamos el montaje de grupo de buzones, sin envoltente.

	Cód.	€
Montaje bloques buzones sin envoltente de 1 a 16 uds.	99962	155,00
Montaje bloques buzones sin envoltente de 17 a 32 uds.	99963	260,00
Montaje bloques buzones sin envoltente de 33 a 50 uds.	99964	365,00
Montaje bloques buzones sin envoltente de más de 50 uds.	99965	470,00

TARIFA DE PRECIOS (IVA NO INCLUIDO)

ENVOLVENTES

Estructuras para unión y protección de conjuntos de buzones sobrepuestos sobre paredes o sobre pies o brazos.



Acero galvanizado o acero inoxidable Basic

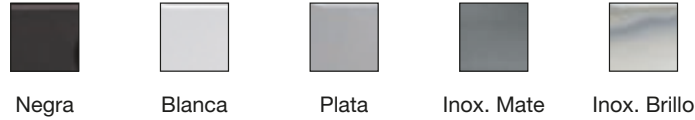

	Cód.	€	Cód.	€	Cód.	€	Cód.	€	Cód.	€
Envolvente con trasera										
8-12 cm fondo	10290	63,00	10291	63,00	10292	67,00	10397	85,80	10391	85,80
12-25 cm fondo	10293	83,00	10294	83,00	10295	88,00	10398	112,20	10392	112,20
26-35 cm fondo	10296	94,30	10297	94,00	10298	102,00	10399	129,80	10393	129,80

PRECIOS POR METRO LINEAL

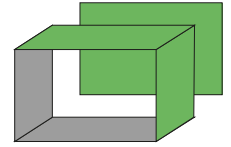

Envolvente de acero galvanizado pintado y acero inoxidable.



Acero galvanizado o acero inoxidable Doble

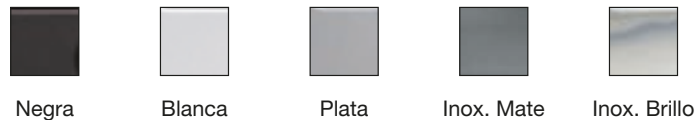

	Cód.	€	Cód.	€	Cód.	€	Cód.	€	Cód.	€
Envolvente con trasera										
8-25 cm fondo	10371	108,00	10372	108,00	10373	115,00	10374	156,00	10364	156,00
26-35 cm fondo	10375	122,00	10376	122,00	10377	132,00	10378	181,00	10366	181,00

PRECIOS POR METRO LINEAL

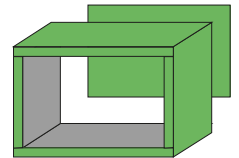

Envolvente de acero galvanizado pintado y acero inoxidable.



Aluminio



	Cód.	€	Cód.	€
Envolvente con trasera				
<300 mm. fondo	10160	116,00	10162	116,00
>300 mm. fondo	10163	138,00	10165	138,00

PRECIOS POR METRO LINEAL

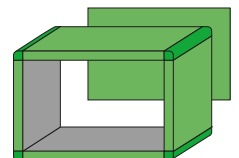

Doble envolvente de aluminio pintado con cantoneras redondeadas de ABS.



Melamina o Madera Trasera



	Cód.	€	Cód.	€
Envolvente				
125 mm fondo	10194	51,00	10195	54,00
250 mm fondo	10196	64,00	10197	70,00
300 mm fondo	10198	67,00	10199	72,00

PRECIOS POR METRO LINEAL

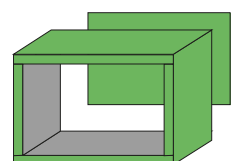

En melaminado o en madera de 18 mm de espesor.

* Ver maderas disponibles en pág. 46

TAPAJUNTAS

Tapajuntas para buzones empotrados. Cubre y protege el espacio entre el conjunto de buzones y el hueco de la pared preparado para empotrar. Enmarca el bloque de buzones proporcionando un mejor acabado. **Precios por metro lineal.**

Aluminio Básico



Natural
Cód. 05507
€ 23,70



Dorado
Cód. 05508
€ 24,70



Bronce
Cód. 05506
€ 24,70

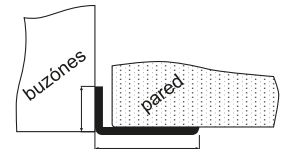
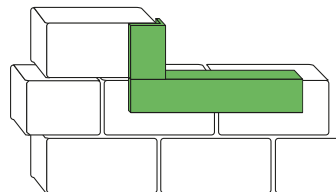

Aluminio Lujo

Aluminio anodizado y cantoneras metálicas



Natural
Cód. 05502
€ 61,80



Dorado
Cód. 05503
€ 68,50



Bronce
Cód. 05501
€ 68,50

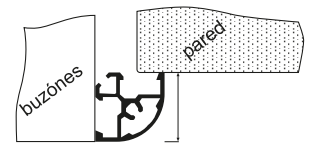
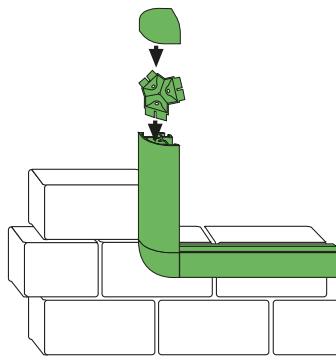

Aluminio Plus

Aluminio pintado negro y cantoneras en ABS también en negro.



Negro
Cód. 04220
€ 65,90

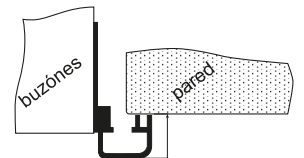
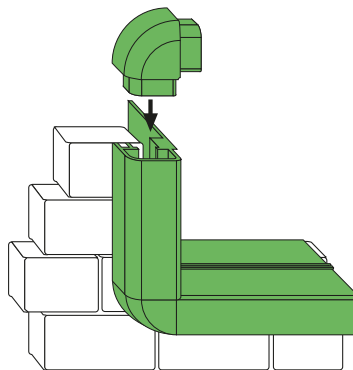

Acero Inox.



Inox.
Cód. 05505
€ 30,00

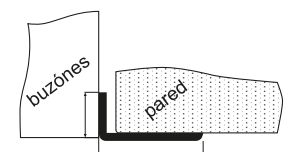
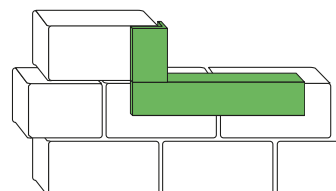

Madera (ver pág. 46)



Básico madera
Cód. 05504
€ 18,50

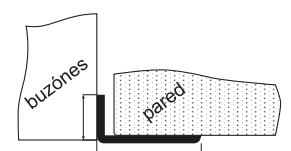
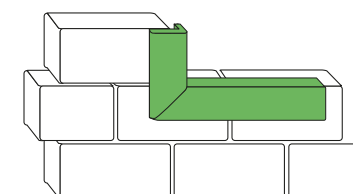





TODOS LOS PRECIOS SON POR METRO LINEAL

TARIFA DE PRECIOS (IVA NO INCLUIDO)





SOPORTES Y BRAZOS

Brazo-Lateral Cuadrado

Soporte principal cuadrado + embellecedor

	Cód.	€/ud.
		
Estructura		
 Negro	10229	115,00
 Blanco	10230	115,00
 Plata *	10231	121,00

Soporte suplementario + embellecedor

	Cód.	€/ud.
		
Estructura		
 Negro	10232	89,00
 Blanco	10233	89,00
 Plata *	10234	94,00

* Recomendado uso interior

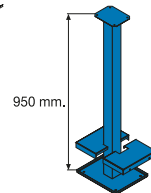
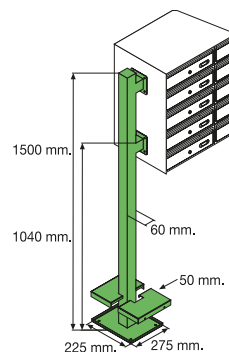





Medida según composición bloque buzones







Brazo-Lateral Redondo

Soporte principal redondo + embellecedor

	Cód.	€/ud.
		
Estructura		
 Negro	10235	114,00
 Blanco	10236	114,00
 Plata *	10237	120,00

Soporte suplementario + embellecedor

	Cód.	€/ud.
		
Estructura		
 Negro	10238	85,00
 Blanco	10239	85,00
 Plata *	10240	90,00

* Recomendado uso interior

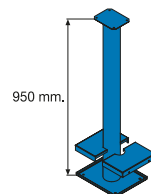
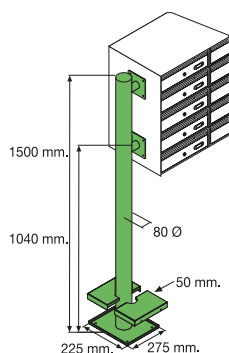





Medida según composición bloque buzones



Brazos Pared

Girando la pieza 180° las medidas son 272 x 172 mm. por lo que consigue mayor separación de la pared.

	Cód.	€/ud.
		
Estructura		
 Negro	10260	86,00
 Blanco	10261	86,00
 Plata *	10262	90,00

Kit soporte brazo pared + embellecedor (2 uds.)

* Recomendado uso interior

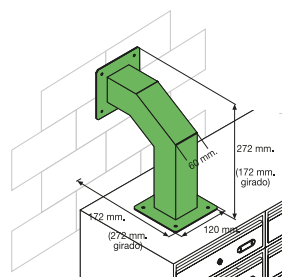

Perfiles suelo a pared

Perfiles de aluminio natural. Terminaciones en plástico resistente.

Soporte lateral (unidad)

Cód. 10241 € 92,00

	Cód.	€ M.lineal
		
Opción bandeja		
Bandeja de madera con tope de aluminio	10249	55,00
Bandeja de madera	10627	44,00
Bandeja de melamina	10626	28,00

Máximo 1,5 m. de ancho.

* Recomendado uso interior

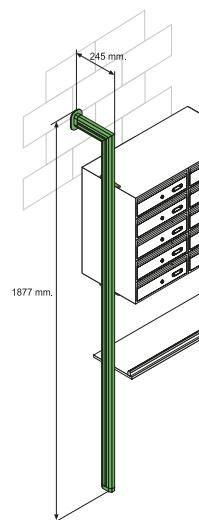

SOPORTES

Acero galvanizado pintado o inoxidable.

Soporte suelo en dos alturas Básico

Alto 800 mm.

Colores	Cód.	€
Negro	04215	59,00
Blanco	10220	59,00
* Plata	10221	62,00

Alto 900 mm.

Colores	Cód.	€
Negro	04216	63,00
Blanco	10222	63,00
* Plata	10223	66,00

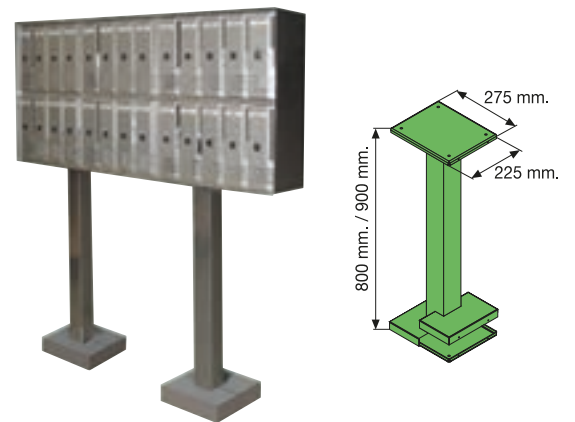

* Recomendado uso interior.

Soporte suelo Octogonal

Colores	Cód.	€
Acero inox. 950 mm.	04213	169,20
Acero inox. 700 mm.	10217	149,50
Blanco 700 mm.	10218	78,00
Negro 700 mm.	10219	78,00

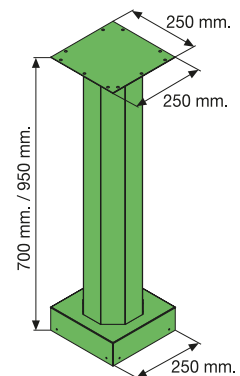

Soporte suelo Curvo

Colores	Cód.	€
Negro	10226	312,00
Blanco	10227	295,00

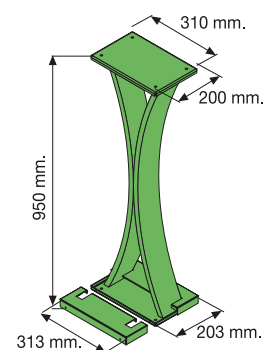

MARQUESINAS

Marquesina sobre pie Arco

Conjunto de 2 soportes principales izda. y dcha. + embellecedores.

	Cód.	€
Estructura		
■ Negro	10242	320,00
■ Blanco	10243	320,00

Cubierta de metacrilato y perfiles m. lineal.

	Cód.	€
Cubierta		
■ Metacrilato blanco al ácido	10270	110,00
■ Metacrilato gris	10271	128,00

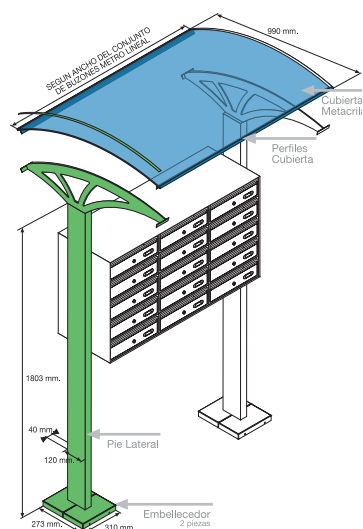

Conjunto pie y arco supletorio (necesario a partir de 1,5 m.).

	Cód.	€
Estructura supletoria		
■ Negro	10245	195,00
■ Blanco	10246	195,00

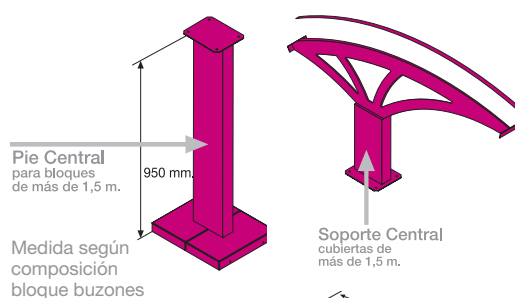

Marquesina pared Arco

Pareja soportes laterales.

	Cód.	€
Estructura		
■ Negro	10263	75,00

Cubierta de metacrilato y perfiles m. lineal.

	Cód.	€
Cubierta		
■ Metacrilato blanco al ácido	10270	110,00
■ Metacrilato gris	10271	128,00

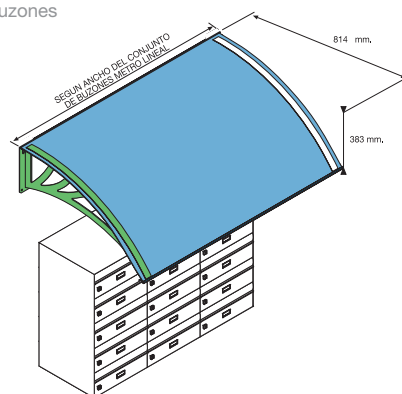

Kit marquesina pared Arco 1m.

Todos los elementos incluidos para una sencilla autoinstalación. Multitud de aplicaciones.

	Cód.	€
■ Negro	10248	175,00



Marquesina pared Recta

Acero galvanizado pintado.

	Cód.	€
Estructura		
■ Negro	10568	64,00

	Cód.	€
Cubierta		
■ Metacrilato blanco al ácido	10272	75,90
■ Metacrilato gris	10273	86,50

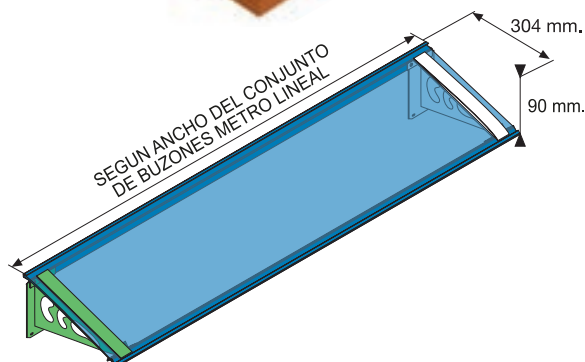

Pareja soportes laterales.

Cubierta de metacrilato y perfiles metro lineal.

TEJADOS

Tejado 1 agua Básico

Acero galvanizado pintado Voladizo frontal de 95 mm.

	Cód.	€
Estructura		
Inox.	10561	155,00
Negro	10562	92,00
Blanco	10563	92,00

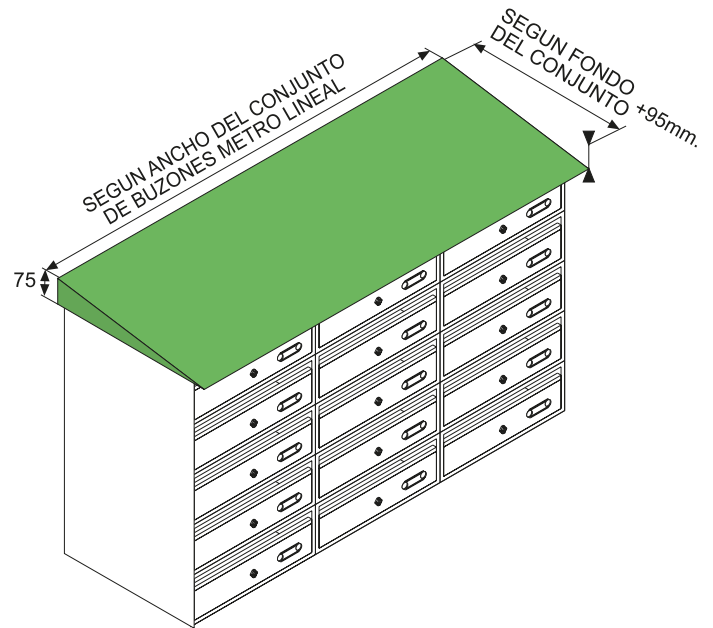

Iluminación LED

Convertir una agrupación de buzones en un elegante elemento decorativo en la comunidad, es ahora posible con la incorporación de de la iluminación mediante leds de luz blanca.

La "opcion led" incluye la instalación de los leds en el voladizo del tejado, quedando estos cubiertos con una tapa de metacrilato translúcido. El efecto conseguido es el de una iluminación matizada y elegante.

El led es la luz más ecológica y energéticamente más eficiente. Ofrece más de 45.000 horas de uso, con una bajísima emisión de calor y reducido consumo.

Incluye 1,5 m. de cable para su conexión a la red eléctrica. Opcionalmente, puede dotarse de un detector de presencia para que se ilumine únicamente ante el paso de personas.

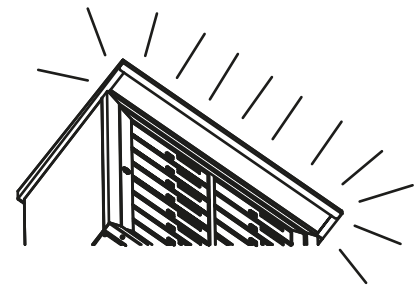

	Cód.	€
Hasta 1 m.	10564	175,00
Hasta 2 m.	10565	210,00

Para opciones de más de 2 m., consultar.



TERMINACIONES Y COLORES GAMA BTV



ACABADOS PERSONALIZADOS

Pintamos su buzón metálico en el color que mejor encaje con la decoración, a partir de un pedido mínimo de 20 unidades. El precio base de partida para calcular el coste del cambio de color, es el precio del modelo color negro o blanco de cada buzón.

COLORES LISOS (APTOS PARA INTERIOR Y EXTERIOR)

Cambio de color solo puerta
Cód. 99991 € 1,50/ud.

Cambio de color puerta y cuerpo
Cód. 99992 € 2,50/ud.



RAL 5021
Azul agua



RAL 5008
Azul grisáceo



RAL 5013
Azul cobalto



RAL 5023
Azul lejanía



RAL 3005
Rojo vino



RAL 3003
Rojo rubí



RAL 2003
Naranja pálido



RAL 1003
Amarillo señales



RAL 8015
Castaño



RAL 8025
Pardo pálido



RAL 6001
Verde esmeralda



RAL 6018
Verde amarillento



RAL 4008
Violeta señales



RAL 7000
Gris ardilla

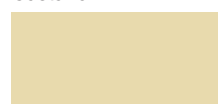

RAL 1015
Marfil claro

COLORES TEXTURIZADOS (APTOS PARA INTERIOR Y EXTERIOR)



RAL 8012
Pardo rojo



RAL 6016
Verde turquesa



RAL 4007
Violeta púrpura



RAL 7032
Gris guijarro



RAL 7015
Gris Pizarra



RAL 7016
Gris Antracita



RAL 7021
Gris negruzco



RAL 7035
Gris luminoso

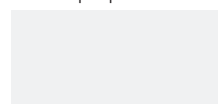

RAL 9003
Blanco señales



RAL 9005
Negro intenso

COLORES EFECTO METALIZADO (NO RECOMENDADOS PARA BUZONES DE EXTERIOR)

Cambio de color solo puerta
Cód. 99988 € 3,00/ud.

Cambio de color puerta y cuerpo
Cód. 99989 € 5,00/ud.

Novedad



Verde Pistacho



Azul Océano



Marrón lava



Plata



Titanio



Arena



Magma



Dorado



CERRADURAS AMAESTRADAS

Es posible equipar su buzón o conjunto de buzones con cerraduras amaestradas. De esta manera, cada individuo tendrá una llave diferente que

abrirá su buzón, pero al mismo tiempo existirá una llave que abrirá todos los buzones del conjunto. Consúltenos.

Cód. 60297

€ 3,00

SOPORTE ANTICAÍDA

Varillas de acero galvanizado que se adaptan a la mayoría de modelos de buzón para evitar la caída de la correspondencia al abrir la puerta.



PERMITE ABRIR EL BUZÓN VERTICAL SIN CAÍDA DEL CORREO.

Incluye dos varillas de acero galvanizado para buzones de ancho de 255 a 325 mm.

Cód. 60066

€ 6,30

KIT SUJETABUZONES DE EXTERIOR

Este kit permite sujetar el buzón en vallas y alambrados.

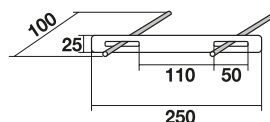

KIT SUJETABUZONES EXTERIOR

Fabricado en Acero.
Aplicable a diferentes modelos. Consultar.

Cód. 10280

€ 5,95

TARJETEROS

Blister



**TARJETEROS
ACERO INOXIDABLE**
Cód. 60012 € 7,20



**TARJETEROS
PLÁSTICO**
Cód. 60013 € 4,70

Acero Inoxidable (bolsas de 5 unidades)



Acero inox. dorado
Medidas interiores:
60 x 24 mm + tornillería.
Cód. 60602 € 18,75



Acero inox.
Medidas interiores:
60 x 24 mm + tornillería.
Cód. 60603 € 16,50

- | | | |
|-----------|----------|-----------|
| Abeto | Estafeta | Ronda |
| Alpes | Europa | Royal |
| Aneto | Gante | Servicios |
| Aranjuez | Grecia | Támesis |
| Astún | Hércules | Torre |
| Avant | Imperio | Venecia |
| Bohemia | Londres | |
| Bruselas | Mónaco | |
| Century | Nature | |
| Dinamarca | Niza | |
| Emperador | Ordesa | |

Plástico (bolsas de 10 unidades)



Medidas interiores: 75 x 16 mm.
Cód. 60605 € 17,60
Horizonte
Oasis



Medidas interiores: 64 x 16 mm.
Cód. 60614 € 12,50
Chalet
Colonia
Venus



Medidas interiores: 65 x 25 mm.
Cód. 60608 € 9,10
Castillo Sevilla
Chalet Teide
Colonia Toledo
Garden Venus
Ibiza
Moncayo Mural
Mercurio



Medidas interiores: 78 x 22 mm.
Cód. 60609 € 9,10
Barajas Imperio Metálico
Everest Paisaje



Medidas interiores: 65 x 25 mm.
+ tornillería.
Cód. 60607 € 17,00
Mallorca



Medidas interiores: 62 x 16 mm.
Cód. 60606 € 12,50
Ebro Prisma Frontal
Expo Silver
Prisma



Medidas interiores: 58 x 14 mm.
Cód. 60610 € 37,80
Atenas Mega
City Posta
Lago

BLISTER CERRADURAS



Cod. 60001



Cod. 60004

Preparados para la mayoría de modelos de buzones con diferentes lengüetas.

DESCRIPCIÓN	Cód.	€
Cerradura diamante cromo	60001	6,80
Cerradura diamante oro	60004	7,20
Cartero cromo para uso de Correos	60011	6,80
Cartero dorada para uso de Correos	60014	7,20

REPUESTOS

Puertas de buzón

- Puertas metálicas: 75% valor del buzón
- Puertas madera: 70% valor del buzón.



Cod. 60006



Cod. 60008

Preparados para la mayoría de modelos de buzones con diferentes lengüetas.

DESCRIPCIÓN	Cód.	€
Cerradura logo cromo	60006	6,80
Cerradura cartero logo para uso de Correos	60008	6,80

REPUESTOS

Puertas de buzón

- Puertas metálicas: 75% valor del buzón
- Puertas madera: 70% valor del buzón.

Llaves en bruto y lengüetas



Para todas las cerraduras de puertas de buzones de madera y metacrilato y algunos modelos de metal (consultar). 36 uds.

Cód. 60430

€ 10,25



Llave en bruto.
10 uds.

Cód. 03003

€ 9,30



Llave en bruto doble
dentado. 10 uds.

Cód. 03007

€ 9,30









Llave en bruto
cerradura logo. 10 uds.

Cód. 60611

€ 9,80

CERRADURAS

MODELO				MODELO			
ABETO			60443*	LISBOA	60469		
ALHAMBRA			60472	LOGO		60455	
ALPES	60448			LONDRES	60441 (cromo)		
ALPES INOX	60449			MALLORCA	60408		
ANETO	60414 (cromo) 60413 (oro)	60463		MERCURIO	60401 (cromo) 60412 (oro)		
ANUNCIOS	60446 (cromo - llaves iguales) 60447 (oro - llaves iguales) 60420 (cromo - llaves diferentes)	60475 (cromo - llaves diferentes)		MONACO	60440	60467	
ARANJUEZ	60442* + 60430 60001 (kit cromo) 60004 (kit oro)			MONCAYO	60406 (cromo) 60405 (oro)	60466	
ASTÚN	60439* + 60430 (oro) 60442* + 60430 (cromo) 60001 (kit cromo) 60004 (kit oro)			MONCAYO MURAL	60406	60466	
ATLANTIS		60465		MURAL INDIV	60401 60407		
AVANT	60456	60463		NANO			60471
BARAJAS	60407 (cromo)	60455		NANO INOX			60471
BERLIN	60469			NIZA	60442* + 60430 60001 (kit cromo) 60004 (kit oro)		
BERMEO	60469			OASIS		60501	
BOHEMIA	60448			OLYMPO		60465	
BOHEMIA INOX	60449			ORDESA	60442* + 60430 60001 (kit cromo) 60004 (kit oro)		
BRUSELAS	60442* + 60430 60001 (kit cromo) 60004 (kit oro)		60443*	PAISAJE	60409 (cromo)	60461	
CAJAS CAUDALES			60458	PANERA	60456 (serreta) 111031 (pomo)		111014 (puntos)
CASTILLO	60409	60461		PORTALLAVES			60459
CENTURY	60406	60466		POSTA		60460 60506	
CENTURY CITY		60502		PRISMA	60407 60409	60455	
CHALET	60401	60450		PRISMA FRONTAL	60407 60409	60455	
COLONIA	60401	60450		RECOGECARTAS	60402	60457	
CORTIJO	60469			RIVIERA		60461	
DINAMARCA	60442* + 60430 60001 (kit cromo) 60004 (kit oro)			RONDA	60442* + 60430 60001 (kit cromo) 60004 (kit oro)		
EBRO	60402	60464		ROYAL	60442* + 60430 60001 (kit cromo) 60004 (kit oro)		
EMPERADOR	60432			RUBI		60503	
EVEREST	60438			SERVICIOS	60409 (cromo)	60461	
EXPO	60402	60464		SEVILLA	60425 (cromo) 60426 (oro)		
FORJA INOX			60504	SILVER		60450	
GALAXY		60465		TÁMESIS	60442* + 60430 60001 (kit cromo) 60004 (kit oro)		
GARDEN	60408			TEIDE	60402 (cromo) 60403 (oro)	60457	
GENOVA		60502		TOLEDO	60425		
GONDOLA		60462		TOKYO		60462	
HÉRCULES	60439* + 60430 60001 (kit cromo) 60004 (kit oro)			TOPACIO		60503	
HORIZONTE		60468 60445 60503		TORRE			60427 (cromo) 60428 (oro)
IBIZA	60408			URBAN	60407 (cromo)	60455	
IMPERIAL			60505	VENUS	60401 (cromo) 60412 (oro)	60450	
IMPERIO	60442* + 60430 60001 (kit cromo) 60004 (kit oro) 60436			VENECIA	60442* + 60430 60001 (kit cromo) 60004 (kit oro)		
LAGO		60502					
LAREDO	60473						

* Referencias 60429, 60439 y 60442 - se distribuyen sin lengüeta

BOLSAS DE 6 UNIDADES

							
60401 17,25 €	60402 17,25 €	60403 17,25 €	60405 17,25 €	60406 17,25 €	60407 19,00 €	60408 19,00 €	60409 19,00 €
							
60412 17,25 €	60413 17,25 €	60414 19,00 €	60419 29,50 €	60425 22,80 €	60426 22,80 €	60427 29,50 €	60428 29,50 €
							
60429 39,50 €	60432 29,50 €	60436 29,50 €	60438 29,50 €	60439 22,80 €	60440 22,80 €	60441 22,80 €	60442 22,80 €
							
60443 39,50 €	60445 17,25 €	60446 22,80 €	60447 22,80 €	60448 17,25 €	60449 17,25 €	60450 19,00 €	60455 19,00 €
							
60456 22,80 €	60457 19,00 €	60458 17,25 €	60459 17,25 €	60460 19,00 €	60461 19,00 €	60462 19,00 €	60463 19,80 €
							
60464 19,80 €	60465 19,00 €	60466 19,00 €	60467 19,80 €	60468 19,00 €	60469 17,25 €	60471 17,25 €	60472 17,25 €
							
60473 17,25 €	60475 19,00 €						

BOLSAS DE 2 UNIDADES

				
60502 17,25 €	60503 17,25 €	60504 17,25 €	60505 17,25 €	60506 17,25 €

BOLSAS DE 1 UNIDAD

	
111014 22,80 €	111031 32,80 €

PRIMERO



ROTULACIÓN

ENTREGA

Cuidando hasta el último detalle.
Presentación en empaquetado de diseño.



FACILIDAD

Tu pedido de rótulos a sólo un
click en el portal BTV.



Índice alfabético

Colgadores Easy		<i>Novedad</i> Pág. 94	Placas Fun	PRIMERO SEGUNDO	Pág. 90
Embellecedor-Separador		Pág. 90	Rótulos zonas comunes	126 <i>Novedad</i>	Pág. 90
Expositor rotulación		Pág. 90	Señalización	0 1 2 CBF	Pág. 92
Placas Classic		Pág. 91	Señalización Homologada		Pág. 95

Índice por páginas

Placas Fun	Pág. 90	Placas Classic	Pág. 91
Rótulos zonas comunes	Pág. 90	Señalización	Pág. 92
Embellecedor-Separador	Pág. 90	Colgadores Easy	Pág. 94
Expositor Rotulación.....	Pág. 90	Señalización Homologada	Pág. 95

PLACAS FUN

Iris

Placas de metacrilato recortado de 4 mm de espesor. Cantos pulidos. Gran contraste con la pared según color elegido. Textos desde 1 hasta 12 caracteres (letras o números).

PRIMERO SEGUNDO

Cód.	Núm. caracteres	€
71224	De 1 a 2	7,75
71225	De 3 a 8	15,60
71226	De 9 a 12	19,00

Opaco			Translúcidos		
Negro brillo	Rojo cereza	Azul océano	Verde menta	Amarillo girasol	Naranja
Vinilo Color:					
Blanco	Blanco	Blanco	Blanco	Negro	Negro

RÓTULOS PARA ZONAS COMUNES

Realizamos rótulos personalizados para áreas comunes. Consúltenos.

Novedad

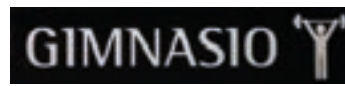
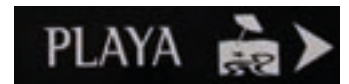
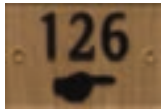

EMBELLECEDOR SEPARADOR

Blister con 8 embellecedores cromados para fijar y decorar su rótulo en la pared. El blister incluye todos los elementos para la fijación de los embellecedores.



Soporte embellecedor. Separador cromado. Blister 8 uds.
Cod. 10370 € 22,00

EXPOSITOR ROTULACIÓN

Expositor de rótulos y números realizado sobre placa de metacrilato. Decore su punto de venta a la vez que muestra las terminaciones de los rótulos BTv.

Alto 100 cm.
Ancho 50 cm.
Cod. 95001 € 125,00



PLACAS CLASSIC

Metacrilato

Placas de metacrilato transparente o translúcido de 4 mm o de acero inoxidable brillo o mate. Letras en plástico ABS o vinilo negro. Placas de 35x8 incluyen hasta 8 caracteres ABS, a definir en pedido. Placas de 8x8 incluyen 1 carácter ABS. Placas de 12x8 incluyen 2 caracteres.

Fijación mediante adhesivo o silicona (no incluido con los rótulos). Series Chipre y Malta también disponibles en tamaños 120x120, 200x200 y 400x100.

CHIPRE*



MALTA*



Cód.	Acabado	Letras	cm.	€
71200	Transparente	ABS plata	35x8	17,00
71208	Transparente	ABS plata	12x8	7,70
71201	Transparente	ABS plata	8x8	7,10
71202	Transparente	ABS oro	35x8	17,00
71209	Transparente	ABS oro	12x8	7,70
71203	Transparente	ABS oro	8x8	7,10
71204	Translúcido	ABS plata	35x8	17,00
71210	Translúcido	ABS plata	12x8	7,70
71205	Translúcido	ABS plata	8x8	7,10
71206	Translúcido	ABS oro	35x8	17,00
71211	Translúcido	ABS oro	12x8	7,70
71207	Translúcido	ABS oro	8x8	7,10

Cód.	Acabado	Letras	cm.	€
71220	Transparente	vinilo negro	35x8	14,20
71221	Transparente	vinilo negro	8x8	6,30
71222	Translúcido	vinilo negro	35x8	14,20
71223	Translúcido	vinilo negro	8x8	6,30

* Metacrilatos disponibles en variedad de colores (ver pág. 82)

Acero inoxidable

BLACK



CÓRCEGA



CRETA



Cód.	Acabado	Letras	cm.	€
71212	Mate	vinilo negro	35x8	11,80
71213	Mate	vinilo negro	8x8	7,30
71214	Brillo	vinilo negro	35x8	11,80
71215	Brillo	vinilo negro	8x8	7,30

Cód.	Acabado	Letras	cm.	€
71280	Mate	vinilo negro	35x8	10,95
71281	Mate	vinilo negro	8x8	7,10
71282	Brillo	vinilo negro	35x8	10,95
71283	Brillo	vinilo negro	8x8	7,10

Cód.	Acabado	Letras	cm.	€
71250	Mate	Abs Plata	35x8	14,10
71251	Mate	Abs Plata	8x8	8,15
71252	Mate	Abs Oro	35x8	14,10
71253	Mate	Abs Oro	8x8	8,15
71254	Brillo	Abs Plata	35x8	14,10
71255	Brillo	Abs Plata	8x8	8,15
71256	Brillo	Abs Oro	35x8	14,10
71257	Brillo	Abs Oro	8x8	8,15

Madera

Placas en madera de 10 mm con cantos biselados. Letras en plástico ABS o latón cromado. Placas de 35x8 incluyen hasta 8 caracteres ABS o latón, a definir en pedido. Placas de 8x8 incluyen 1 carácter ABS o latón.

ÍTACA



RODAS



Cód.	Acabado	Letras	cm.	€
71300	Haya	Plata	35x8	16,90
71301	Haya	Plata	8x8	7,10
71302	Haya	Oro	35x8	16,90
71303	Haya	Oro	8x8	7,10
71310	Roble	Plata	35x8	16,90
71311	Roble	Plata	8x8	7,10
71312	Roble	Oro	35x8	16,90
71313	Roble	Oro	8x8	7,10
71315	Caoba	Plata	35x8	16,90
71316	Caoba	Plata	8x8	7,10
71317	Caoba	Oro	35x8	16,90
71318	Caoba	Oro	8x8	7,10

Cód.	Acabado	Letras	cm.	€
71352	Haya	Doradas	35x8	20,25
71353	Haya	Doradas	8x8	7,40
71362	Roble	Doradas	35x8	20,25
71363	Roble	Doradas	8x8	7,40
71372	Caoba	Doradas	35x8	20,25
71373	Caoba	Doradas	8x8	7,40

SEÑALIZACIÓN

Construidos en acero inoxidable mate de 1 mm. (excepto Pitágoras 15,5 cm., cuyo grosor es de 2 mm.). Instalación mediante cinta de doble cara o silicona (no se incluyen). Numeración de portales o plantas.

Signum

Placas en acero inoxidable de Ø 7,5 ó 10 cm.



SIGNUM diámetro 10 cm. € 5,50
SIGNUM diámetro 7,5 cm. € 4,50

Cód.	Cód.	Símbolo
Ø 10 cm.	Ø 7,5 cm.	
71400	71406	Señoras
71401	71407	Sr./Sra.
71402	71408	Caballeros
71403	71409	Minusválidos
71404	71410	Cambiador bebé
71405	71411	No fumar

Pitágoras

Caracteres en acero inoxidable recortado a láser.



PITAGORAS alto 8,5 cm. (grosor 1 mm.)

€ 3,75

Cód.	Caracter	Cód.	Carac.	Cód.	Carac.
71450	0	71463	D	71475	O
71451	1	71464	E	71476	P
71452	2	71465	F	71477	Q
71453	3	71466	G	71478	R
71454	4	71467	H	71479	S
71455	5	71468	I	71480	T
71456	6	71469	J	71481	U
71457	7	71470	K	71482	V
71458	8	71471	L	71483	W
71459	9	71472	M	71484	X
71460	A	71473	N	71485	Y
71461	B	71474	Ñ	71486	Z
71462	C				

PITAGORAS alto 15,5 cm. (grosor 2 mm.)

€ 6,45

Cód.	Carac.	Cód.	Carac.	Cód.	Carac.
71425	0	71429	4	71433	8
71426	1	71430	5	71434	9
71427	2	71431	6	71435	a
71428	3	71432	7	71436	b

Latón

Construidos en latón envejecido. Números en latón pulido dorado del 0 al 9. Placas para 1, 2 ó 3 números. Incluye

tornillos y tacos de anclaje a pared. Caracteres en acero inoxidable recortado a láser.

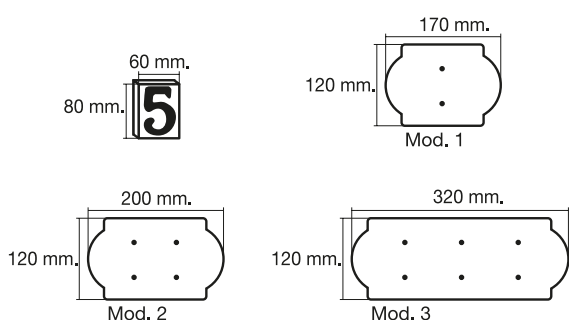

LATÓN NÚMEROS

€ 16,90

Cód.	Carac.	Cód.	Carac.	Cód.	Carac.
70864	0	70868	4	70872	8
70865	1	70869	5	70873	9
70866	2	70870	6		
70867	3	70871	7		

LATÓN PLACAS PARA 1, 2 ó 3 NÚMEROS

Cód.	Números	€
70861	1	29,00
70862	2	32,00
70863	3	35,00

Alphabet números y letras

Fabricados en ABS plata y oro. Incluye pegatina autoadhesiva. Expositores para blister.

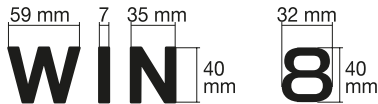

Expositores para alphabet

Expositor giratorio. Capacidad 740 blisters



Expositor sencillo. Capacidad 370 blisters

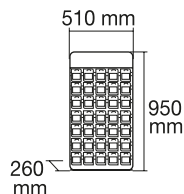
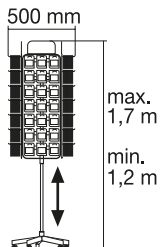

ALPHABET NÚMEROS

€ 1,00

En oro y plata

Núm. ABS	Oro Cód.	Plata Cód.
0	71577	71527
1	71578	71528
2	71579	71529
3	71580	71530
4	71581	71531
5	71582	71532
6	71583	71533
7	71584	71534
8	71585	71535
9	71586	71536

ALPHABET LETRAS

€ 1,00

En oro y plata

Núm. ABS	Oro Cód.	Plata Cód.
A	71550	71500
B	71551	71501
C	71552	71502
D	71553	71503
E	71554	71504
F	71555	71505
G	71556	71506
H	71557	71507
I	71558	71508
J	71559	71509
K	71560	71510
L	71561	71511
M	71562	71512
N	71563	71513
Ñ	71564	71514
O	71565	71515
P	71566	71516
Q	71567	71517
R	71568	71518
S	71569	71519
T	71570	71520
U	71571	71521
V	71572	71522
W	71573	71523
X	71574	71524
Y	71575	71525
Z	71576	71526

SET EXPOSITOR SENCILLO + 370 blisters

(37 mods. x 10 uds)

Letras plata

Cód. 71601

Letras oro

Cód. 71602

€ 290,00

SET EXPOSITOR GIRATORIO/ EXTENSIBLE + 740 BLISTERS

(74 mods. x 10 uds)

Cód. 71600

€ 625,00

Colgadores reutilizables EASY STICK

Novedad

Los EASY STICK son un novedoso concepto de colgadores de fácil aplicación. Su sistema de fijación está patentado, no precisa de herramientas para su colocación y no deja marcas ni manchas ya que **no lleva pegamento**. Idóneo para superficies no porosas como baldosa y cristal.

Se suministran por unidades sueltas. Embalaje de 10 uds.



Colgador redondo y transparente

Ø68mm. Cód. 10730 1,75 €



Colgador redondo y transparente

Ø100mm. Cód. 10731 2,25 €



Regleta 3 colgadores transparente

70 x 270mm. Cód. 10732 5,85 €



Porta escobas transparente

100x100mm. Cód. 10733 5,90 €



Señalizador WC - Fondo plateado

Ø100mm. Cód. 10734 3,10 €



Colgador redondo balón Ø100mm..

Fútbol Cód. 10735 2,90 €

Baloncesto Cód. 10736 2,90 €

- Sistema de pegado patentado
- Ecológico y económico
- Apto para superficies no porosas

· Precauciones

- No colocar en techos
- No colocar en superficies a más de 60°C
- No utilizar con objetos peligrosos o frágiles

· Instrucciones



Limpiar la superficie con un trapo seco



Retirar el papel protector del adhesivo



Presionar suavemente sobre el área de colocación



Para reutilizarlo, despegar, lavar la suciedad con agua y secar la zona del adhesivo para recuperar la capacidad de pegado

SEÑALIZACIÓN



Evacuación

22,4 x 22,4 cm. / 16 x 32 cm.

€ 5,45

71700 	71701 	71708 	71710
71702 	71703 	71704 	71705
71707 29,7 x 10,5 cm. 	71709 29,7 x 22,4 cm. 		

Extinción

29,7 x 21 cm.

€ 5,45

71712 	71713 29,7 x 21 cm. 	71714 	71715 21 x 15 cm.
-----------	----------------------------	-----------	--------------------------

Otros

29,7 x 22,4 cm.

€ 5,45

71711 29,7 x 22,4 cm.

Prohibición

29,7 x 21 cm.

€ 4,95

71721
71722

Obligación

29,7 x 21 cm.

€ 4,95

71725 	71726 	71727
71728 	71729 	71730

Advertencia

29,7 x 21 cm.

€ 4,95

71740 	71741
71742 	71743

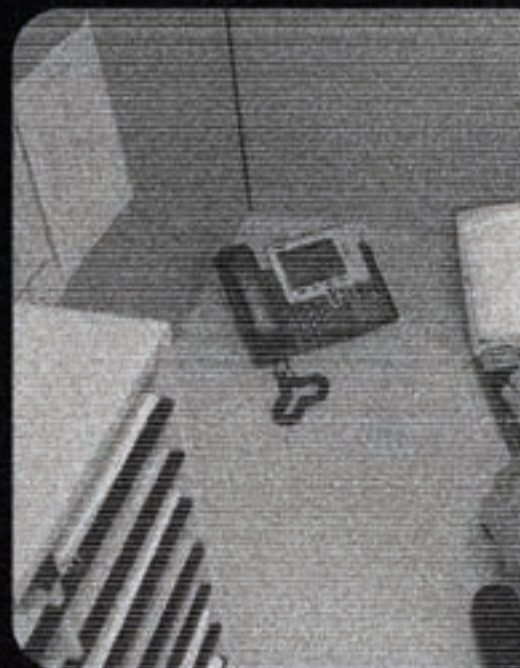
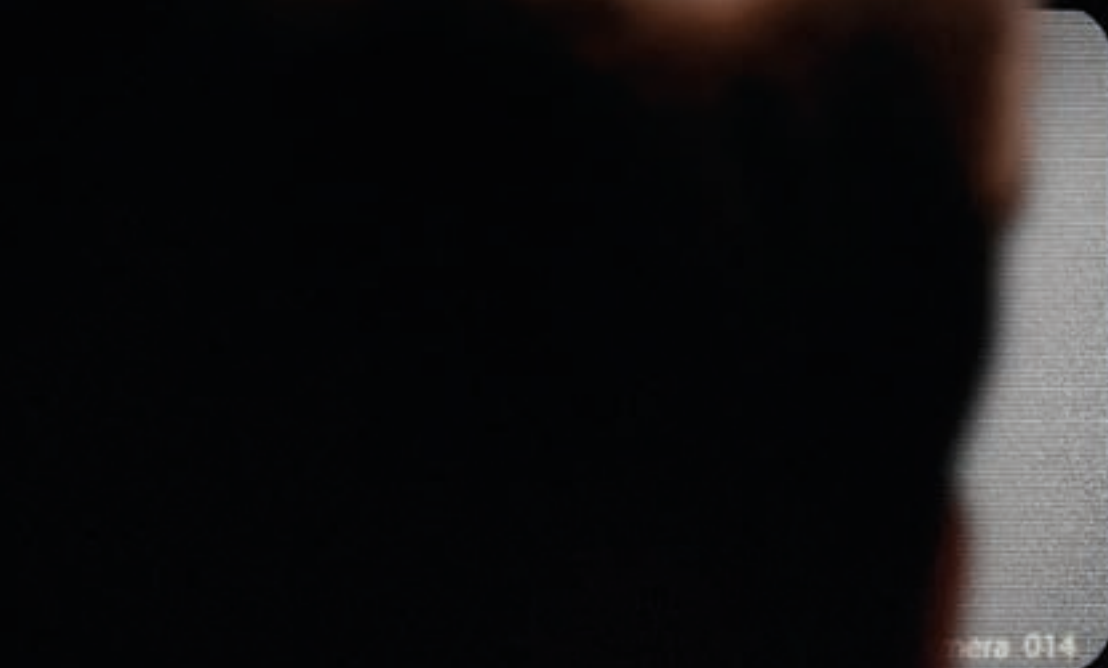

SEGURIDAD Y VIDEOVIGILANCIA



Índice alfabético

Cerraduras
electrónicas



Novedad

Pág. 100

Llaveros de
seguridad



Pág. 102

Domótica



Novedad

Pág. 102

Videovigilancia



Pág. 98

Índice por páginas

Videovigilancia.....Pág. 98

Cerraduras electrónicas.....Pág. 100

Domótica.....Pág. 102

Llaveros de seguridadPág. 102

VIDEOVIGILANCIA

Ideales para cualquier establecimiento, entrada o salida, fábricas, oficinas, comunidades, domicilios particulares y zonas comunes. Siéntase seguro al mejor precio.

Cámaras simuladas



Cód. 60707

Cámara simulada para exterior
Construida en ABS
Alta resistencia

€ 27,00



Cód. 60706

Cámara simulada para exterior
Construida en ABS
Con led indicador

€ 23,00



Cód. 01415

Cámara simulada para exterior
Color Blanco
Led Indicador intermitente
Alimentación interior: pilas R14
Cuatro meses ininterrumpidamente

€ 16,00

Kit grabador Simply 1



Incluida

Cód. 60710

Grabador DVR con cable de 2 canales y 2 cámaras
Grabación por detección de movimiento
Foto a foto
Vídeos de 5 y 10 segundos
Visión nocturna hasta 10 m.
Imágenes o vídeo en formato AVI recogidas en tarjeta SD 2 GB
Tarjeta 2 GB incluida
Posibilidad de visualizar imágenes en PC

€ 129,00

Cámaras con sensor SONY 1/4" de 420 líneas de TV.
Visión nocturna hasta 15 m (12 leds infrarrojos en cámara).

Permite reproducir, grabar y visualizar simultáneamente.
Posibilidad de conexión a red local e Internet (también a través de dispositivos móviles Symbian, iPhone, Windows CE o Android de Google).

- Grabación hasta un mes con calidad media.
- Cuatro u ocho canales.
- Disco duro integrado de 500 GB.
- 18 m de cable incluidos por cámara.

Cámaras con normativa IP65 de resistencia al agua.
Activación por movimiento.



Kit 15" DVR 4 canales integrado

Cód. 60701

Kit 15" + 4 cámaras
Grabador de imagen DVR de 4 canales
4 cámaras
Pantalla LCD 15"
Autoconfigurable con router

€ 590,00



Kit 19" DVR 8 canales integrado

Cód. 60703

Kit 19" + 8 cámaras
Grabador de imagen
DVR de 8 canales
8 cámaras
Pantalla LCD 19"

€ 890,00



DVR Safe electrónica



Opción bandeja extraíble sobre guías

DVR Safe

Caja fuerte motorizada o bien solo llave, diseñada para alojar un grabador DVR y protegerlo así de usos indebidos o manipulaciones.

Modelo electrónico con retardo de 1 a 99 minutos.

Dispone de orificios de salida de cables en la zona trasera.

Fabricada de acuerdo a la orden INT/317/2011 artículo 4, que describe como deben protegerse los equipos de registro de imágenes.

Espesor puerta: 4 mm.

Espesor cuerpo: 2 mm.

Cerradura de gorjas o teclado.

Bulones Ø 10 o Ø 20 mm.

Cód. 01448	Mecánica	€ 165,00
Cód. 01450	Electrónica	€ 195,00
Cód. 70150	Bandeja (opción)	€ 52,00

CERRADURAS ELECTRÓNICAS

Novedad

Cerradura capacitiva Loxx



Detalle pestillo de seguridad

- Cerradura electrónica de teclado capacitivo o con tarjeta.
- Maneta reversible (apertura tanto a derechas como a izquierdas).
- Uso interior.
- Fácil instalación y limpieza.
- Códigos programables hasta 8 usuarios y 50 tarjetas.
- Funciona con 4 pilas AA no incluidas.

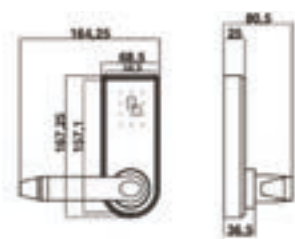

Cód. 01424

€ 156,00



Cerradura Dalí Inox



- Acabado en acero inoxidable.
- Hasta 200 códigos de usuario: uso muy sencillo.
- Función «apertura con una sola tecla» para uso frecuente.
- Utiliza 4 pilas AA standard. Consumo 0 W.
- Función aviso de pilas bajas más toma de alimentación exterior.
- Llave de puntos de alta seguridad para apertura de emergencia.
- Para puertas de entre 40 y 60 mm. de espesor.
- Incluye instrucciones, plantilla, tornillería y cerrojo tipo Euro.

Cerradura Serie CE



- Hasta 7 códigos de usuario más un código Master para el administrador del sistema.
- Función «apertura con una sola tecla» para uso frecuente.
- Utiliza 4 pilas AA standard. Consumo 0 W.
- Función aviso de pilas bajas más toma de alimentación exterior.
- Llave de puntos de alta seguridad para apertura de emergencia.
- Para puertas de entre 40 y 60 mm. de espesor.
- Atractiva presentación en blister que incluye instrucciones, plantilla, tornillería y pestillo.



Cerrojo Euro

Color: acero inox.

Cód. Izda. 05401
Cód. Dcha. 05400

€ 173,50
€ 173,50

Mod. CE 1099

Color: cromado brillo

Cód. Izda. 05205
Cód. Dcha. 05206

€110,00
€110,00

Mod. CE 1098

Color: oro

Cód. Izda. 05203

€ 110,00

DOMÓTICA

Eyewatch

- Sistema Domótico de Vigilancia y Alarma.

Este conjunto de cámara, grabador y transmisor de imágenes comunica con su móvil para poder controlar su hogar a distancia. Requiere conexión 3G, 4G o wifi.

- Grabación y reproducción simultánea de audio y vídeo.
- Grabación manual, por alarma o programada.
- Función vídeo-llamada.
- Conexión por cable o wireless.
- Almacenamiento de datos en tarjeta SD.
- Aviso vía e-mail cuando se genera algún tipo de alarma.
- Visualización vía móvil o tablet.

Cód. 01407

€ 275,00

Novedad



LLAVEROS DE SEGURIDAD

Keytronic

- Código de uso + llave de emergencia.
- Teclado plano.
- Cuatro pilas interiores de 1,5 V. Llave de emergencia.
- Fijación a la pared trasera.
- Dos bulones de 20 mm. Ø
- Llave de emergencia.

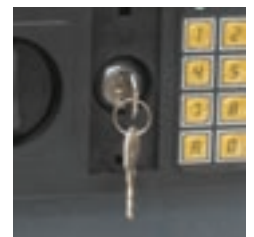

Llave de emergencia



Keytronic-30

30 llaves
Alto 340 - Ancho 400 - Fondo 120

Cód. Izda. 70555

€ 116,50



Keytronic-50

50 llaves
Alto 340 - Ancho 400 - Fondo 120

Cód. Izda. 70556

€ 155,00

COMPLEMENTOS

Índice alfabético

Anuncios 	Pág. 104	Clasificadores de llaves 	Pág. 106
Botiquines 	Pág. 116	Guardallaves 	Pág. 114
Caja de ocultación 	Pág. 114	Huchas 	Pág. 113
Cajas de caudales  <i>Novedad</i>	Pág. 112	Imanes 	Pág. 105
Ceniceros 	Pág. 115	Linternas y pilas 	Pág. 118
Cestas de publicidad 	Pág. 108	Papeleras 	Pág. 110

Índice por páginas

Anuncios	Pág. 104	Huchas.....	Pág. 113
Imanes	Pág. 105	Guardallaves	Pág. 114
Clasificadores de llaves	Pág. 106	Caja de ocultación.....	Pág. 114
Cestas de publicidad.....	Pág. 108	Ceniceros.....	Pág. 115
Papeleras	Pág. 110	Botiquines	Pág. 116
Cajas de caudales.....	Pág. 112	Linternas y pilas.....	Pág. 118

ANUNCIOS

Diseño

Construidos en perfil extrusionado de aluminio. Cantoneras en material ABS de gran calidad. Tablero trasero en chapa pintada en blanco y puertas en metacrilato transparente de

alta resistencia. Cerradura de seguridad. Incluye imanes de fijación para las notas a exponer.



VERTICAL 1
Capacidad
1 DIN A4

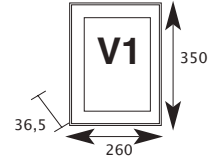

VERTICAL 2
Capacidad
4 DIN A4

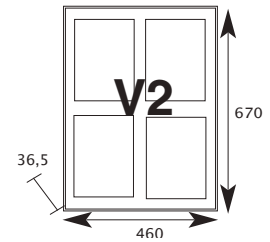

HORIZONTAL
Capacidad
2 DIN A4

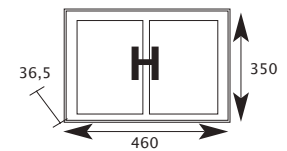

V1

V2

H

Opción llaves iguales

Colores	Cód.	Cód. EAN	€	Cód.	Cód. EAN	€	Cód.	Cód. EAN	€	Cantidad	Cód.	Cód. EAN	€
		8421461			8421461			8421461				8421461	
Marco													
Blanco	00125	001252	47,50	00127	001276	84,00	00126	001269	59,50	De 5 a 10 uds.	99970	999702	26,00
Negro	00128	001283	47,50	00130	001306	84,00	00129	001290	59,50	De 11 a 20 uds.	99971	999719	35,00
Natural	00131	001313	49,50	00133	001337	86,00	00132	001320	61,50	Más de 20 uds.			Sin cargo



Flat

Construidos en perfil de aluminio, sin puerta. Marco autobloqueo-clip sobre lámina plastica y transparente. Capacidad para dos o cuatro hojas tamaño A4.

Flat H

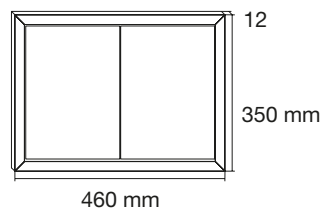

FLAT V

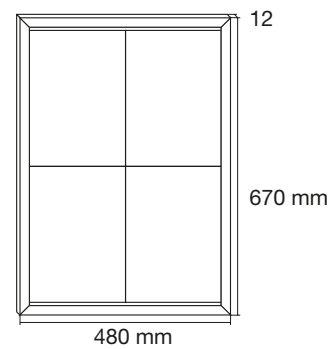

Colores	Mod.	Cód.	Cód. EAN	€	Mod.	Cód.	Cód. EAN	€
			8421461				8421461	
Marco								
Natural	Flat H-1	10960	109606	22,50	Flat V-1	10963	109637	25,30
Oro	Flat H-2	10961	109613	22,50	Flat V-2	10964	109644	25,30
Pintado blanco	Flat H-3	10962	109620	25,60	Flat V-3	10965	109651	28,50



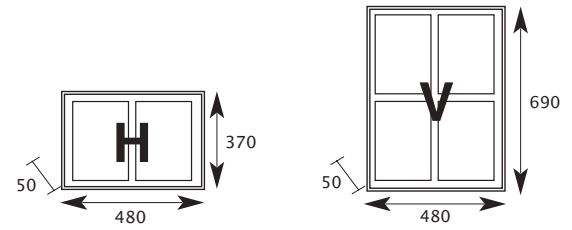

Madera

Construidos con cuerpo de madera y puertas en metacrilato transparente de alta resistencia.



HORIZONTAL
Capacidad 2 DIN A4

VERTICAL
Capacidad 4 DIN A4

Colores	H			V		
	Cód.	Cód. EAN 8421461	€	Cód.	Cód. EAN 8421461	€
Marco						
 Bubinga	00113	001139	66,00	00114	001146	79,00
 Roble	00115	001153	66,00	00116	001160	79,00

Opción llaves iguales

Cantidad	Cód.	Cód. EAN 8421461	€
De 5 a 10 uds..	99970	999702	26,00
De 11 a 20 uds.	99971	999719	35,00
Más de 20 uds.			Sin cargo

IMANES

6 imanes de Ø 30 mm.

Mod.	Cod.	Cód. EAN 8421461	€
Negro	10030	100306	2,35
Gris	10031	100313	2,35
Multicolor	10032	100320	2,35



CLASIFICADORES DE LLAVES



Aluminio

Construidos en perfil extrusionado de aluminio. Cantoneras en material ABS de gran calidad (cromado brillo). Tablero trasero en chapa pintada en blanco y puertas en metacrilato transparente de alta resistencia. Incluye llaveros.



Colores	Llaves/peso	Medidas	Cód.	Cód. EAN 8421461	€
Acabado					
Natural	16 llaves / 1,2 kg	200 x 300 x 35	04103	041036	44,30
Natural	32 llaves / 2,2 kg	400 x 300 x 35	04104	041043	56,15
Natural	22 llaves / 1,5 kg	200 x 400 x 35	04105	041050	49,90
Natural	55 llaves / 3,2 kg	500 x 400 x 35	04106	041067	75,20

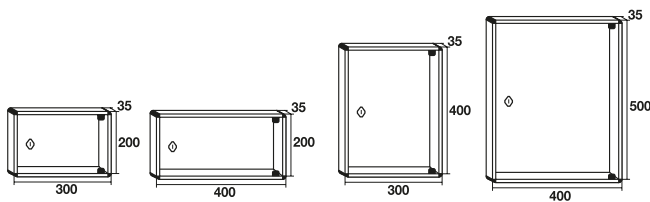

16 llaves 22 llaves 32 llaves 55 llaves

Opción llaves iguales	Cód.	Cód. EAN 8421461	€
De 5 a 10 uds.	99970	999702	26,00
De 11 a 20 uds.	99971	999719	35,00
Más de 20 uds.	Sin cargo		



Inoxidable

Construidos en acero inoxidable. Con 9 colgadores.

9 llaves

245 x 215 x 65 mm

Cod. EAN: 8421461041456

Cod. 04145

€ 15,90

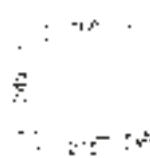



20 llaves



Acero colgadores fijos

Clasificador de llaves con apertura de libro.
Hoja índice y llaveros de etiquetado incluido.

Portallaves

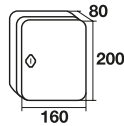

20 llaves

Uds./caja: 20
160 x 200 mm
Cod. EAN:
8421461041302
Cod. 04130
€ 13,50

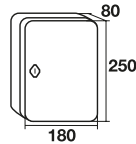

48 llaves

Uds./caja: 20
180 x 250 mm
Cod. EAN:
8421461041319
Cod. 04131
€ 18,50

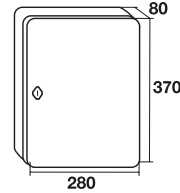

60 llaves

Uds./caja: 6
370 x 280 mm
Cod. EAN:
8421461041326
Cod. 04132
€ 23,50

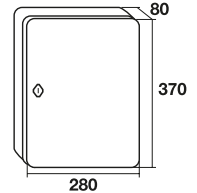

160 llaves

Uds./caja: 6
370 x 280 mm
Cod. EAN:
8421461041418
Cod. 04141
€ 43,00

Acero colgadores regulables

Clasificador de llaves con apertura de libro. Ganchos ajustables en altura. Hoja índice y llaveros de etiquetado incluido.

Clasificadores

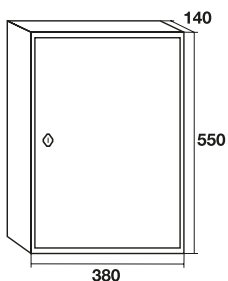

200 llaves

1 hoja
550 x 380 x 140 mm
Cod. EAN:
8421461112002
Cod. 11200
€ 79,00

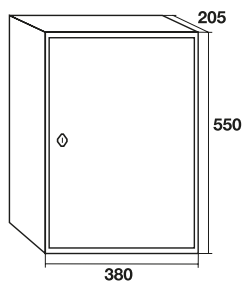

300 llaves

2 hojas
550 x 380 x 205 mm
Cod. EAN:
8421461113009
Cod. 11300
€ 125,00



CESTAS DE PUBLICIDAD

Dune



Fabricadas en chapa de acero pintada o acero inoxidable brillo.
Disponible en dos tamaños y en colores blanco, negro e inox. brillo.

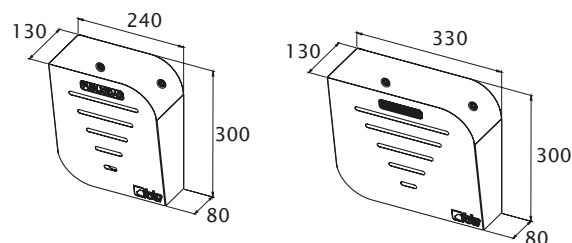

Ancho 240

Ancho 330

Colores	Ancho 240			Ancho 330		
	Cód.	Cód. EAN 8421461	€	Cód.	Cód. EAN 8421461	€
Blanco	10880	108807	21,00	10890	108906	24,00
Negro	10881	108814	21,00	10891	108913	24,00
Inox. brillo	10882	108821	36,00	10892	108920	43,00



Adhesivo incluido con cada cesta





Portal

Construidas en acero pintado o en acero inoxidable.

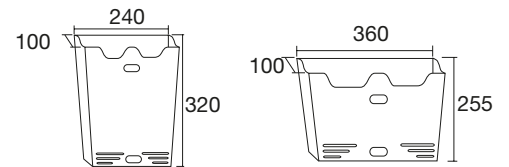

Ancho 240
Uds./caja: 7

Ancho 360
Uds./caja: 6



Colores	Cód.	Cód. EAN 8421461	€	Cód.	Cód. EAN 8421461	€
Blanco	00153	001535	22,25	00180	001801	25,00
Negro	00154	001542	22,25	00181	001818	25,00
Inox. brillo	00157	001573	38,90	00186	001863	44,50



Adhesivo incluido
con cada cesta



Diseño

Construidas en chapa de acero pintado o en acero inoxidable brillo.

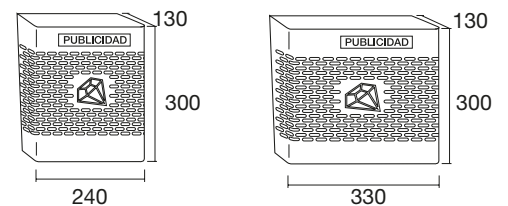

Ancho 240
Uds./caja: 6

Ancho 330
Uds./caja: 4

Colores	Cód.	Cód. EAN 8421461	€	Cód.	Cód. EAN 8421461	€
Blanco	00240	002402	27,50	00330	003300	34,00
Negro	00241	002419	27,50	00331	003317	34,00
Inox. brillo	00243	002433	43,50	00333	003331	52,00



Adhesivo incluido
con cada cesta



PAPELERAS



Dune

Fabricadas en chapa de acero pintada o acero inoxidable brillo.
Disponibles en dos tamaños y en colores verde, negro e inox. brillo.

Ancho 240 mm. 330 mm.

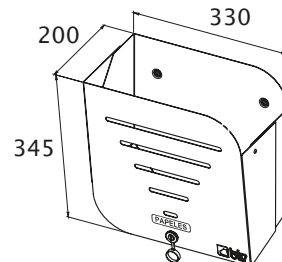
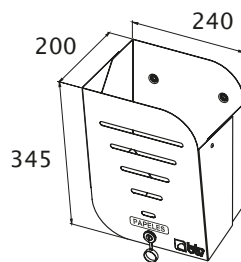

Colores	Cód.	Cód. EAN 8421461	€	Cód.	Cód. EAN 8421461	€
Verde	13940	139405	33,00	13950	139504	42,00
Negro	13941	139412	33,00	13951	139511	42,00
Inox. brillo	13942	139429	47,00	13952	139528	59,50

Diseño

Construidas en acero pintado o acero inoxidable brillo.

Ancho 240 mm.



Incluye adhesivos

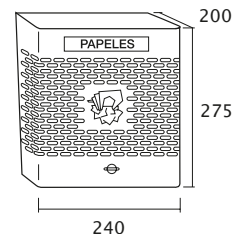

Colores	Cód.	Cód. EAN 8421461	€
Verde	03941	039415	33,00
Inox. brillo	03946	039460	45,00

Garaje

Fabricadas en acero pintado y provistas de cerradura.



Incluye adhesivos



150

430

300

Colores		Mod.	Cód.	Cód. EAN 8421461	€
	Verde	1	03901	039019	41,40
	Blanco	14	03914	039149	41,40
	Negro	20	03920	039200	41,40



MOD. 22



MOD. 23



MOD. 30



MOD. 31



MOD. 32

Oficina

Fabricadas en acero pintado en blanco, negro o en acero inoxidable mate.

Colores		Mod.	Medidas	Cód.	Cód. EAN 8421461	€
	Blanco	22	650 x Ø 215	03922	039224	66,50
	Blanco	23	680 x 190 x 190	03923	039231	66,50
	Inox. mate	30	620 x 240 x 240	13930	139306	68,50
	Inox. mate	31	650 x Ø 300	13931	139313	78,00
	Negro	32	650 x Ø 300	13932	139320	65,00



CAJAS DE CAUDALES

Serie ahorro

Construidas en acero de alta resistencia. Bandeja portamonedas incluida. Colores: azul, verde, negro y rojo. El mod. 10 dispone de ranura para introducir monedas. Disponemos de llaves en bruto.



Display

Color: negro
556 x 270 x 310
Cód. EAN:
8421461800213
Cod. 80021
€ 24,00

Mod.	Medidas Al. x An. x F.	Cód. Azul	Cód. EAN 8421461	€	Cód. Verde	Cód. EAN 8421461	€	Cód. Rojo	Cód. EAN 8421461	€	Cód. Negro	Cód. EAN 8421461	€	Cód. Beige	Cód. EAN 8421461	€	
10	60 x 125 x 95	50	01730	017307	7,20	01731	017314	7,20	01732	017321	7,20	01734	017345	7,20	01733	017338	7,20
11	80 x 150 x 115	24	01740	017406	7,75	01741	017413	7,75	01742	017420	7,75	01744	017444	7,75	01743	017437	7,75
12	90 x 200 x 160	20	01750	017505	9,30	01751	017512	9,30	01752	017529	9,30	01754	017543	9,30	01753	017536	9,30
13	90 x 250 x 190	16	01760	017604	12,35	01761	017611	12,35	01762	017628	12,35	01764	017642	12,35	01763	017635	12,35
14	90 x 300 x 240	10	01770	017703	14,90	01771	017710	14,90	01772	017727	14,90	01774	017741	14,90	01773	017734	14,90



Travel box 1



Travel box 2

Travel box

Maletín de seguridad para Viajes. / Cerradura eléctrica de 3 a 8 dígitos. / Cerradura de emergencia. / Lazo de anclaje 84 cm.

Mod.	Medidas Al. x An. x F.	Cod.	Cód. EAN 8421461	€
Travel box 1 azul	85 x 255 x 215	10820	108203	29,90
Travel box 2 negra	85 x 330 x 245	10821	108210	32,95

Wallet *Novedad*

Caja de seguridad portátil construida en aluminio (carcasa exterior) y acero (cajón interior). Diseñada para guardar valores como teléfonos, cámaras, carteras, gafas y otros pequeños objetos. Puede amarrarse mediante la sirga (incluida) al chasis del vehículo, o bien a armarios u otros elementos.

Alto 210 - Ancho 150 - Fondo 55 mm.
1,5 kg. de peso

Cód. 10699

€ 24,90

Cod. EAN: 8421461106995



Detalle de la caja de seguridad con la sirga de fijación al vehículo.



Wallet abierta

HUCHAS

Modelo caja fuerte

Secreto de combinación.
Ranura en la parte trasera para introducir las monedas.



Mod.	Cod.	Cód. EAN 8421461	€
Rojo	11782	117823	9,80
Azul	11781	117816	9,80

GUARDALLAVES

Corinto

Caja para la custodia de llaves, fabricada en acero fundido de gran resistencia y solidez, ideal para la ocultación de llaves pequeñas. Con código reprogramable de 4 dígitos. Indicada para contener llaves tanto de elementos de su hogar como de su oficina.

CORINTO 1

Diseñado para atornillar a la pared, muebles, etc. Incluye tornillería para instalación.

Alto 90 - Ancho 60 - Fondo 40

Cód. 11310 € 18,50

Cód. 8421461113108

CORINTO 2

Con aro de sujeción tipo candado para su uso en verjas, vallas, etc.

Alto 130 - Ancho 60 - Fondo 40

Cód. 11311 € 20,60

Cód. 8421461113115



CORINTO 1

CORINTO 2

CAJA DE OCULTACIÓN

Caja-Libro

Original caja de caudales con llave mecánica ideal para contener efectivo y pequeños objetos de valor. Su aspecto exterior en formato libro, pasará completamente desapercibida entre los libros de su biblioteca. Incluye juego de fundas exteriores de diversa temática para que pueda elegir el formato que mejor se adapte a su colección.

Alto 240 - Ancho 150 - Fondo 55 mm.

0,8 kg. de peso

Cód. 10825 € 15,75

Cód. 8421461108258



CENICEROS

Pared

El humo en la calle pero las colillas en el cenicero. Disponen de cajetín extraíble para fácil limpieza.



Mod.	Medidas	Cód.	Cód. EAN 8421461	€
Mod. 1	305 x 242 x 92	10830	108302	19,95
Mod. 2 inox	150 x 200 x 60	10831	108319	24,70
Mod. 3	120 x 200 x 80	10832	108326	19,60



Tubular

Ceniceros construidos en acero inoxidable (calidad 304). Diseño elegante y contemporáneo.



Colores	Medidas	Cód.	Cód. EAN 8421461	€
Tubular suelo	960 x Ø 80	10840	108401	152,00
Tubular pared	600 x Ø 80	10841	108418	115,00

BOTIQUINES



Serie Plus

Fabricado en acero pintado al horno, con tratamiento anticorrosivo y adhesivo de cruz. Estantes en puerta para alojar objetos en su interior. Bandejas anticaída. Disponible en color blanco.



Puerta con capacidad para alojar objetos

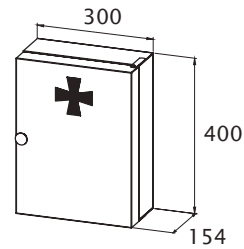

Mod.	Cod.	Cód. EAN 8421461	€
Blanco	10005	005045	42,50

Estándar

Fabricados en acero, pintado al horno con tratamiento anticorrosivo y adhesivo de cruz en verde. Color blanco.

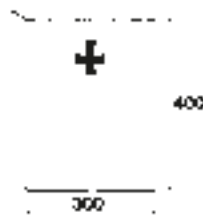

120 100
Cod. Cod.
00504 00505

Mod.	Cod.	Cód. EAN 8421461	€
Puerta con tirador	00504	005045	35,00
Puerta con cerradura	00505	005052	32,50



Glass

Fabricados en acero mate y **metacrilato** acabado ácido con diseño de cruz en cristal transparente. Cierre magnético.

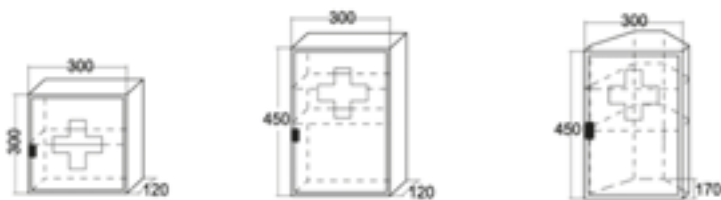

Mod.	Cod.	Cód. EAN 8421461	€
Cuadrado	00591	005915	25,00
Vertical	00592	005922	28,00
Rinconera *	00593	005939	29,00

* Hasta fin de existencias



LINTERNAS



LINTERNA + 24 PILAS AA

Linterna de Aluminio
Un led 1 W larga duración
Pack 24 pilas LR6 AA 1,5
Pedido mínimo caja 12 ud.

Cód. 10652

€ 10,30

Cód. EAN: 8421461106520



LINTERNA + 24 PILAS AA

Linterna de Aluminio
Un led 1 W larga duración
Pack 24 pilas LR3 AAA 1,5
Pedido mínimo caja 12 ud.

Cód. 10653

€ 11,50

Cód. EAN: 8421461106537



MEGA 1059E

Linterna de Aluminio
21 leds 1,5 W larga duración
3 pilas LR3 AAA 1,5 (no incluidas)
Pedido mínimo caja 10 ud.

Cód. 00737

€ 4,45

Cód. EAN: 8421461007377



MEGA 339

Linterna de Aluminio
9 leds 0,5 W larga duración
3 pilas LR3 AAA 1,5 (no incluidas)
Pedido mínimo caja 10 ud.

Cód. 00736

€ 3,90

Cód. EAN: 8421461007360

PILAS

Especiales para cajas fuertes y cerraduras electrónicas.



safePOWER

4 pilas/blister
LR06 AA 1,5 V
Alcalinas
Pedido mínimo caja 30 blister

Cód. 77770

€ 1,50

Cód. EAN: 8421461777706



safePOWER

4 pilas/blister
LR03 AAA 1,5 V
Alcalinas
Pedido mínimo caja 30 blister

Cód. 77780

€ 1,50

Cód. EAN: 8421461777805



safePOWER

Recargables
4 pilas/blister
HR06/2500mAh 1,2 V
Alcalinas
Pedido mínimo caja 12 blister

Cód. 10655

€ 6,90

Cód. EAN: 8421461106551



4 EXPOSITOR PILAS

alto 415 mm
ancho 235 mm
fondo 150 mm

Cód. 80026

€ 15,00

Cód. EAN: 8421461800268

CATÁLOGO DE CAJAS FUERTES

BTV es especialista en la fabricación de cajas fuertes de sobreponer, empotrar, alta seguridad, armeros y cajas ignífugas. Sus productos están avalados por diferentes certificaciones nacionales e internacionales.

¡SOLICÍTELOS!

No dude en solicitar nuestro catálogo de cajas fuertes en el correo: btv@btv.es

Catálogo en formato PDF disponible en: http://www.btv.es/descargas/BTV_Cajas_2014.pdf



CATÁLOGO DE HOTEL

BTV dispone de un extenso catálogo de productos especiales para hoteles. Cajas fuertes, minibares, muebles bar, accesorios para habitaciones y baños, videovigilancia y muebles de jardín.



Amplia información de gama específica para hotel en el correo: hotel@btv.es

Catálogo en formato pdf disponible en: <http://www.btv.es/DescargasHotel.php>



PRESENTACIÓN EN EL PUNTO DE VENTA

BTV proporciona a sus clientes expositores, pósters y carteles para apoyar promociones y añadir valor al punto de venta.

Expositores

Cód. 71620

€ 435,00

Cód. EAN: 8421461716200



Pósters y paneles decorativos



Atractivos empaquetados para góndolas y lineales



Condiciones de venta catálogo Buzones 2015

TARIFAS Y PAGOS

- Las tarifas y condiciones adjuntas entran en vigor el **1 de diciembre de 2014** y sustituyen a todas las editadas con anterioridad a esa fecha.
- Todos los precios indicados son por unidad, IVA no incluido.
- Los retrasos en el pago sobre la fecha de vencimiento acordada, tendrán un recargo por tipo de interés del 0,75% mensual (9% anual).
- OFERTA PEDIDOS ON LINE PORTAL BTV: Los pedidos que el cliente envíe a través del Portal de Clientes de BTV, disfrutarán de un 1% de descuento adicional sobre el neto del pedido.
- Para envíos a ANDORRA (LA VELLA), se incrementará el impuesto DUA según importes. Consultar

EMBALAJE

- En los precios de tarifa van incluidos los embalajes.
- El precio de la tarifa se refiere siempre a la compra del número de unidades o múltiplo de las mismas que contiene un embalaje completo.

PORTES

- Los portes serán pagados hasta la puerta del cliente a nivel de suelo, por pedidos superiores a los siguientes valores netos de la factura, según zonas:

España (península):	200,00€
Baleares:	260,00€
Canarias:	900,00€
Portugal:	600,00€

*Otros destinos, consultar al departamento comercial

- En caso de no superar la franquicia de porte, el envío se realizará a porte debido o bien se cargarán en factura los gastos correspondientes a portes. En concreto para envíos a España (península), se cargarán los siguientes importes fijos:

Hasta 50€:	9,00€
De 50 a 200€:	12,00€

PEDIDOS MÍNIMOS

- BTV NO establece un importe mínimo por pedido.

DEVOLUCIONES

- Solamente se aceptará mercancía en fábrica que contenga claramente identificado el CÓDIGO DE AUTORIZACIÓN DE DEVOLUCIÓN, que el cliente deberá solicitar a BTV previo al envío de la mercancía.
- Producto especial, a medida o descatalogado, no admite devolución.
- El transporte de la mercancía desde origen hasta la fábrica sólo será gestionado por BTV en caso de que la devolución sea debida a causa imputable a BTV.
- Sólo se admitirán devoluciones por causas imputables al cliente, durante los 15 días naturales siguientes al envío de la mercancía.
- En caso de devoluciones por causas imputables al cliente, se abonará el 80% del valor del producto original, siempre que el producto devuelto esté en buenas condiciones técnicas y en su empaquetado original. En caso de devoluciones de productos dañados o sin el empaquetado original, se descontará al menos un 20% adicional.
- El cliente deberá asegurarse del perfecto estado de la mercancía antes de firmar el albarán de entrega de la agencia. A partir de dar su conformidad, el cliente se responsabiliza del estado de la mercancía y dispone de 24 horas para reclamar a la agencia cualquier desperfecto consecuencia del transporte. Si no lo ha notificado a BTV o a la agencia en ese plazo, la reparación correrá a cargo del cliente.
- Las reclamaciones por mercancía dañada en el transporte, se iniciarán con el envío a fábrica de una fotografía del material golpeado. A través de esta fotografía se agilizará la evaluación de los daños, así como el abono o la realización de un presupuesto para su reparación.

MODIFICACIONES DEL PRODUCTO

Con el objetivo de la mejora continua, la empresa se reserva el derecho de modificar en cualquier momento cualquiera de las características técnicas o apariencia estética de sus productos. Las características que se reflejan en el catálogo tienen carácter ilustrativo, y no constituyen un contrato de obligado cumplimiento. Por tanto, cualquier esquema, figura, dimensiones, pesos y otras informaciones de los catálogos, solo constituirán una obligación si así se ha acordado por escrito.





Central y fábrica Zaragoza (España)

Dirección

Ctra. Nacional II, Km. 333
Polígono Industrial BTV - Alfindén
50171 La Puebla de Alfindén
(Zaragoza) España

Tel. 976 108 088

International: +34 976 108 422

Móvil oficina: 615 072 531

Fax: 976 107 321



Consultas departamento comercial
616 996 303 (no pedidos)

Localización GPS

41° 38' 24" N - 0° 46' 03" O



Fábrica de Jiaxing (China)

Dirección

Jiaxing (cerca de Shanghái) China

Localización GPS

30° 48' 08" N - 120° 47' 09" E



Oficina y almacén en Cancún (Méjico)

Dirección

Av. Lib. Kabah, SM 17, Mza 3, Lote 3
CP 77505 Cancún, Quintana Roo (Méjico)

Localización GPS

21° 08' 33" N - 86° 50' 02" O



 El catálogo
en su móvil

Servicio Asistencia Técnica
(S.A.T.) 902 190 386

Servicio de Atención al Cliente
(S.A.C.) 902 877 873

btv@btv.es
www.btv.es